



Spojini, sitni i nosivi okov Okov za kompaktni ploče

24/04/24



Max&Moris



Koncept

Lamello program

Šarnir spojnice

Sitni popratni okov

Nosači

Podloške i odbojnici

Pokrivne naljepnice i kapice

Okov za kompakt ploče

*MAX & MORIS d.o.o. zadržava pravo izmjene tehničkih podataka i cijena bez prethodne najave.
Cijene su iskazane sa uključenim PDV-om od 25%.

Prema odluci Vijeća Europske unije, fiksni tečaj konverzije prema kojem se vrši preračunavanje cijena je:
1 euro = 7,53450 kuna.

Slike u katalogu su informativnog karaktera te ne garantiramo potpunu podudarnost slika i stvarnog izgleda.
Za tiskarske greške ne odgovaramo.



LAMELLO PROGRAM

Povezuje. Inspirira.

“ Sustavna rješenja tvrtke Lamello sinonim su za kvalitetu, inovaciju i funkcionalnost, a upotrebljavaju se diljem svijeta čime su višestruko dokazali svoju vrijednost!

Clamex P-14

Odvojivi konektor za namještaj, za debljine materijala od 16mm

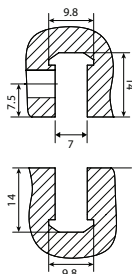

Pakiranje	JM	Šifra art.	Cijena sa PDV-om	
80 parova	pak	151021	163 ⁴⁸ €	1.231 ⁷³ kn
300 parova	pak	151022	579 ²⁴ €	4.364 ²⁵ kn

Clamex S-20

U pakiranju su vijci i šablona za pozicioniranje
Cutter: Ø100x4x22



Pakiranje	dim mm	JM	Šifra art.	Cijena sa PDV-om	
20 par	59x12x3,9	pak	151065	64 ⁹⁷ €	489 ⁵² kn
80 par	59x12x3,9	pak	151066	161 ¹⁴ €	1.214 ¹⁰ kn

Clamex P-10

Odvojivi konektor za namještaj, za debljine materijala od 13mm

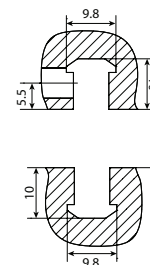

Pakiranje	JM	Šifra art.	Cijena sa PDV-om	
80 parova	pak	151024	163 ⁴⁸ €	1.231 ⁷³ kn

Clamex P-Medius 14/10

Odvojivi konektor za središnje ploče debljine materijala od 16mm

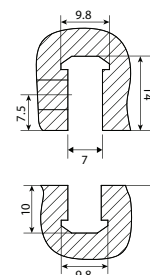

Pakiranje	JM	Šifra art.	Cijena sa PDV-om	
80 parova	pak	151023	163 ⁴⁸ €	1.231 ⁷³ kn

Clamex P-Flexus 14/10

Odvojivi spojnik za namještaj s fleksibilnim klinovima za pozicioniranje a debljine materijala od 18mm i spojevima od 12mm



Pakiranje	JM	Šifra art.	Cijena sa PDV-om	
80 parova	pak	151019	163 ⁴⁸ €	1231 ⁷³ kn
300 parova	pak	151020	579 ²⁴ €	4.364 ²⁵ kn

Tenso P-14

Samozatezni spojnik za lijepljenje za sve kutove

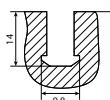
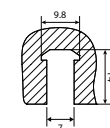

Pakiranje	Spojnica	JM	Šifra art.	Cijena sa PDV-om	
80 parova	bez predzatezne	pak	151025	98 ⁰⁰ €	738 ³⁹ kn
80 parova	sa predzateznom	pak	151026	117 ⁷³ €	887 ⁰⁵ kn
300 parova	sa predzateznom	pak	151028	406 ¹⁹ €	3.060 ⁴⁵ kn

Tenso P-10

Samozatezni spojnik za lijepljenje za tanke izratke debljine materijala od 12mm

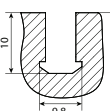
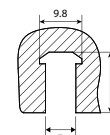

Pakiranje	JM	Šifra art.	Cijena sa PDV-om	
80 parova	pak	151027	117 ⁷³ €	887 ⁰⁵ kn

Drvene spojnice (originalne)

Švicarski proizvod, švicarsko drvo, kvaliteta tvrtke Lamello



Pakiranje	Veličina	JM	Šifra art.	Cijena sa PDV-om	
1000 kom	0	pak	151012	41 ⁸³ €	315 ¹⁷ kn
1000 kom	10	pak	151013	42 ⁶² €	321 ¹² kn
1000 kom	20	pak	151014	43 ⁴¹ €	327 ⁰⁵ kn

Bisco P-14

Lamela za poravnanje za spojnike Clamex P-14 i Tenso P-14

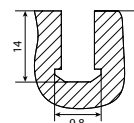
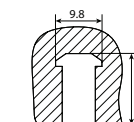

Pakiranje	JM	Šifra art.	Cijena sa PDV-om	
80 komada	pak	151015	37 ⁴¹ €	281 ⁸⁶ kn

Bisco P-10

Lamela za poravnanje za spojnike Clamex P-10

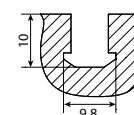
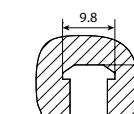

Pakiranje	JM	Šifra art.	Cijena sa PDV-om	
80 komada	pak	151016	33 ⁸⁶ €	255 ¹³ kn

Divario P-18

Samozatezni, nevidljivi konektor za umetanje slajda

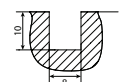
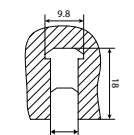

Pakiranje	JM	Šifra art.	Cijena sa PDV-om	
80 parova	pak	151029	123 ⁰¹ €	926 ⁸² kn

Minicol aplikator za ljepljenje

Univerzalni aplikator za ljepljenje



s plastičnom mlaznicom



s metalnom mlaznicom



Mlaznica	JM	Šifra art.	Cijena sa PDV-om	
plastična	kom	151030	62 ³⁰ €	469 ⁴³ kn
metalna	kom	151031	73 ⁷³ €	555 ⁵² kn

Cabineo 8, 12

Spojnik za korpuse koji šteti prostor, za čistu obradu površina i najveću silu zatezanja



Cabineo 8



Cabineo 12

Pakiranje	Duljina vijka	JM	Šifra art.	Cijena sa PDV-om	
500 komada	8mm	pak	151033	259 ²¹ €	1.953 ⁰² kn
500 komada	12mm	pak	151034	259 ²¹ €	1.953 ⁰² kn

Cabineo 8 M6

Spojnik za namještaj povećane čvrstoće otporan na habanje za razne materijale



Pakiranje	Obrada	JM	Kat. broj Lamello	Cijena sa PDV-om
500 komada	crna	pak	186315	na upit
500 komada	bijela	pak	186345	na upit

Invis Mx2 kit

magnetski spojnici

Početni komplet **Invis Mx2** (u spremniku Systainer):

- MiniMag Mx2
- 20 spojnika Invis Mx2 s maticama od 14mm
- Bušaća garnitura Rasto s bušnim alatom od 12mm, mehanizmom za podešavanje dubine, nasadnom čahuricom
- Odvijač
- Opužno vreteno
- Klin za umetanje



	JM	Šifra art.	Cijena sa PDV-om	
početni komplet	set	151039	708 ⁹⁷ €	5.341 ⁷⁰ kn

Šablona za Clamex

Bušaća garnitura za spojnike P-system uklj. bušni alat, od 22,5° za sve spojnike Clamex P (P-10, P-14, P Medius 14/10)



	JM	Šifra art.	Cijena sa PDV-om	
	kom	151006	96 ⁵⁸ €	727 ⁶⁹ kn

Cabineo set 8/12

Pakiranje	JM	Šifra art.	Cijena sa PDV-om	
40 komada	pak	151032	94 ⁹³ €	715 ²² kn

Cabineo insert

Matica za Cabineo 8 M6



Pakiranje	Veličina	Debljina materijala	JM	Kat. broj Lamello	Cijena sa PDV-om
100 kom	M6x12,3	14-16mm	pak	186370	na upit
500 kom	M1 26x12,3	14-16mm	pak	186371	na upit
100 kom	M6x15,3	17-25mm	pak	186375	na upit
500 kom	M6x15,3	17-25mm	pak	186376	na upit

Komplet spojnika Invis Mx2

s maticom od 14 mm



Pakiranje	JM	Šifra art.	Cijena sa PDV-om	
20 komada	set	151038	175 ⁵⁹ €	1.323 ⁰⁰ kn

Glodalo za utore s karbidnim vrhom

ø100 x 8 x 22 mm



Predrezač Z2 + V4, 4 otvora za vijke, glavina za alate Zeta, Top 20, Top 21, Classic



Z6 (3+3), okretni zupci, bez glavine s odstojnom pločicom za alat Classic

Glodalo	JM	Šifra art.	Cijena sa PDV-om	
Z2 + V4	kom	151008	151 ⁸⁸ €	1144 ³¹ kn
Z6 (3+3)	kom	151009	73 ²⁰ €	551 ⁵⁰ kn

Glodalo za utore za spojnike P-System

ø100 x 7 x 22 mm

Z3 dijamantno
glodalo za Zeta
P-2Z3 karbidno
glodalo za Zeta
P-2

Glodalo	JM	Šifra art.	Cijena sa PDV-om	
Z3 dijamantno	kom	151010	303 ⁰⁴ €	2283 ²³ kn
Z3 karbidno	kom	151011	169 ²¹ €	1274 ⁸⁹ kn

P-System basic set

Sadržaj P-System profesionalnog seta:

80 pari Clamex P-14
80 pari Tenso P-14 uključujući spojnik
60 pari Clamex P-14/10 Medius
20 komada Bisco P-14
Tenso P-14/10 alat
Systainer II T-Loc s razdjeljcima



	JM	Šifra art.	Cijena sa PDV-om	
set		151018	500 ⁵⁴ €	3771 ³² kn

Cabineo imbus ključ

Materijal: plastika / čelik

Dugački kuglični šesterokutnik s 1/4" šesterokutnom šipkom



Dimenzija	JM	Šifra art.	Cijena sa PDV-om	
1/4"	kom	501687	1 ⁶⁷ €	12 ⁶⁰ kn

Šablona za Clamex S-20 + svrdlo

Dimenzija	JM	Šifra art.	Cijena sa PDV-om	
svrdlo 6 mm	kom	151067	73 ¹⁴ €	551 ⁰⁷ kn

P-System profesionalni set

Sadržaj P-System profesionalnog seta:

120 pari Clamex P-14
30 pari Clamex P-14/10 Flexus
30 pari Clamex P-10
80 pari Tenso P-14 uključujući spojnik
30 pari Tenso P-10 uključujući spojnik
20 komada Bisco P-14
20 komada Bisco P-10
80 pari Divario P-18
Divario instalacijski alat
Clamex P instalacijski alat
Tenso P-14/10 alat,
Sortainer T-loc



	JM	Šifra art.	Cijena sa PDV-om	
set		151017	978 ⁵⁵ €	7.372 ⁸⁸ kn

Montažni alat za spojnike Clamex P

za sve kutove, brz i fleksibilan

šesterokutni 4 x 30 mm, duljina 290 mm



	JM	Šifra art.	Cijena sa PDV-om	
kom		151035	59 ³⁵ €	447 ²⁰ kn

Cabineo imbus ključ

	JM	Šifra art.	Cijena sa PDV-om	
80mm	kom	151058	74 ³ €	55 ⁹⁵ kn

Šablona za postavljanje Clamex S-20

	JM	Šifra art.	Cijena sa PDV-om	
	kom	151068	16 ⁶⁷ €	125 ⁶⁰ kn

Montažni alat za spojnike Divario P-18

za uglavljivanje u izradak, potreban je za ugradnju



JM	Šifra art.	Cijena sa PDV-om	
kom	151007	128 ⁶⁷ €	969 ⁴⁶ kn

Glodalica set za lamele - Classic X

Glodalica za utore (kekserica) za originalne lamele tvrtke Lamello

Prednosti i značajke:

- Graničnici u ravnini s obje strane
- Okomita stabilnost osigurava se pričvršćivanjem na glavnu ploču kako bi se povećala kontaktna površina
- Savršena preciznost spajanja pod kutom od 22.5 i 45° zahvaljujući graničniku na potpornoj površini
- Mogućnost podešavanja položaja utora na graničnoj površini od 0 do 50 mm
- Potpuno jednaka udaljenost od glodala na obje strane (8 mm)
- Zahvaljujući sigurnosti prilikom obrade uvijek su zajamčeni precizni, paralelni utori jer se visina ne može podešavati
- Pozicioniranje uz zakretni graničnik s držačem razmaka od 4 mm za središnje ploče od 12 mm (utor u sredini)
- Pozicioniranje uz osnovnu ploču — kao granična ploča služi središnja ploča (pomaknuta za 4 mm)
- Visoka preciznost pri obradi graničnih površina
- Kod obrade s pomoću CNC stroja jamči točno postavljanje izratka
- Vodilica za preciznost dugog vijeka trajanja jamči precizne, paralelne utore za savršeno uglavljivanje izradaka

U kompletu Classic X (u spremniku Systemainer):

- Classic X
- Glodalo za utore s karbidnim vrhom
- Usisni adapter 36mm
- Kutni graničnik
- Pričvrtna pločica 4mm
- Komplet alata



Snaga	850W
Napon	230V ili 120V
Broj okretaja	10.000 min ⁻¹
Glodalo	za utore s karbidnim vrhom Ø100x4x22
Zupci	Z6 (3+3) s okretnim zupcima
Maks.dubina urezivanja glodalice	20mm
Težina	2,9kg

Snaga	Napon	JM	Šifra art.	Cijena sa PDV-om	
850W	230 ili 120V	kom	151005	1.037 ²⁹ €	7.815 ⁴⁹ kn

Glodalica set za lamele - Top 21

Glodalica s podesivom visinom glodala

Prednosti i značajke:

- Glodalo podesive visine
- Okretna glava sa skalom, položaj glodala podesiv za +/- 2 mm u stupnjevima od 0,1 mm (ukupno 4 mm)
- Namještanje utora u sredinu izratka (kod debljina materijala od 8 do 24 mm)
- Jednostavno urezivanje utora za spajanje prema naprijed ili prema natrag
- Dvostruki utor 2 x 4 mm za spojnike Clamex S tvrtke Lamello
- Urezivanje razdjelnih fuga, širine od 8 do 12 mm, podesivo u koracima 0,1 mm
- Zasebno pozicioniranje utora za urezivanje
- Snažan motor od 1050 W
- Snažan motor s punovalnom elektronikom s mekim upuštanjem, stalnom regulacijom broja okretaja, zaštitom od preopterećenja, zaštitom od ponovnog uključanja
- Jednostavno servisiranje, iznimno mali troškovi održavanja i popravaka
- Precizno glodalo za utore
- S glavinom i 4 predrezača
- Vrećica za prašinu od tkanine uključena u opseg isporuke
- + usisni adapter Ø 36 mm

Originalna glodalica za utore (kekserica) s mehanizmom za podešavanje visine proizvođača spojnika P-System



Snaga	1 050 W/230 V 800 W/120 V
Brzina	9 000 min ⁻¹
P-System glodalo	Ø 100 × 4 × Ø 22 mm
Zubi	Z2 + V4 sa zubima
Dubina glodanja (max)	20mm
Masa	3,5 kg

Snaga	Napon	JM	Šifra art. (izlog)	Cijena sa PDV-om	
		kom	151002	1.797 ¹³ €	13.540 ⁴⁸ kn

Lamello pokrivna kapa fi 6mm

Pokrivne kapice za Clamex, 100kom 90°, RAL 9010, bijela

Na upit 100kom

- grafitna crna RAL 9011
- hrast, bor RAL 1014
- bež, bukva RAL 1011
- smeđa RAL 8007
- čokoladna RAL 8017
- sivkasto bijela RAL 9002
- svjetlosiva RAL 7035
- prozorskosiva RAL 7040
- plavosiva RAL 7031
- antracit RAL 7022



	JM	Šifra art.	Cijena sa PDV-om	
100kom/bijela	pak	151037	1143€	8609kn

Glodalica set za lamele - Zeta P2

Brza i fleksibilna glodalica

Prednosti i značajke:

- Alat Zeta P2 za brzo, potpuno uglavljenje svih vrsta spojnih okova spojnika P-System
- Zahvaljujući automatskom podiznom mehanizmu stvara se profilirani utor u koji je moguće ručno umetnuti spojne okove
- Ušteda vremena prilikom montaže okova zahvaljujući inovativnoj tehnologiji utora za spojnik P-System. Ručno umetanje okova bez upotrebe ljepila ili vijaka omogućuje znatno kraće vrijeme rada i uštedu dodatnih materijala za pričvršćivanje

Glodalica za uture (kekserica) za spojnik P-System uz koju svakoga dana možete uštediti vrijeme

S pomoću alata Zeta P2 dijelove možete fleksibilno i brzo spojiti pod različitim kutovima i na različite načine. Prikladan je za spajanje pojedinačnih komada namještaja, ali i za prototipe i serijsku proizvodnju.



Snaga	1 050 W/230 V 800 W/120 V
Brzina	9 000 min ⁻¹
P-System glodalica	K: Ø 100.9 × 7 × Ø 22 mm D: Ø 100.4 × 7 × Ø 22 mm
Zubi	Z3
Dubina glodanja (max)	20mm
Masa	3,7 kg

Snaga	Napon	JM	Šifra art. (izlog)	Cijena sa PDV-om	
		set	151004	2.20370€	16.60380kn

Cabineo pokrivne kapice**Na upit** 100kom

- čisto bijela RAL 9010
- papirus bijela RAL 9018
- svijetla slonovača RAL 1015
- bež-smeđa RAL 1011
- crvenkasto-smeđa RAL 8007
- svjetlosiva RAL 7005
- mišje siva RAL 7040
- tamnosiva RAL 9005
- srebro
- nikal
- tamni čelik



pak / obrada	JM	Šifra art.	Cijena sa PDV-om	
100kom/bijela	pak	151042	1491€	11235kn
100kom/crna	pak	151051	1491€	11235kn

Zeta P2 AKKU

Snažni P-system za kekse uz bežičnu slobodu

Prednosti i značajke:

- Fleksibilniji rad u radionici. Priručni stroj za rezanje kekse na baterije osigurava veću učinkovitost i fleksibilnost u radionici.
- Akumulatorska spajalica za kekse znatno olakšava rad na gradilištu – nema potrebe za traženjem utičnica
- Ušteda vremena prilikom montaže okova zahvaljujući inovativnoj tehnologiji utora za spojnik P-System. Ručno umetanje okova bez upotrebe ljepila ili vijaka omogućuje znatno kraće vrijeme rada i uštedu dodatnih materijala za pričvršćivanje

Glodalica za uture (kekserica) za spojnik P-System uz koju svakoga dana možete uštediti vrijeme

S pomoću alata Zeta P2 dijelove možete fleksibilno i brzo spojiti pod različitim kutovima i na različite načine. Prikladan je za spajanje pojedinačnih komada namještaja, ali i za prototipe i serijsku proizvodnju.

U kompletu Zeta P2 AKKU (u spremniku Sustainier) se nalazi:

- Zeta P2 AKKU
- 2 baterije 18V, LiHD 4.0 Ah
- Punjač ASC 55, plug Typ C
- Rezač dijamantni vrh
- Usisni adapter 36 mm
- Kutni graničnik
- Odstojnik 2 mm i 4 mm
- Set alata
- Šablona za bušenje uklj. svrdlo
- Vrećica za prašinu



Baterija	18V
Brzina	9 000 min ⁻¹
P-System glodalica	Ø 100 × 7 × 22 mm
Širina glodanja	7/10mm
Dubina glodanja (max)	20mm
Masa	3,7 kg

Snaga	Napon	JM	Šifra art.	Cijena sa PDV-om	
		set	151048	2.89396€	21.80454kn

Vreća za prašinu

JM	Šifra art.	Cijena sa PDV-om	
kom	151057	58 ¹⁸ €	438 ³⁶ kn

Usisni adapter fi 36mm

za glodalice za utore (kekserice), kompatibilno s alatima tvrtke Festoll



JM	Šifra art.	Cijena sa PDV-om	
kom	151036	24 ¹⁵ €	181 ⁹⁶ kn

Šarnir spojnica

dimenzija	JM	Šifra art.	Cijena sa PDV-om	
30x30mm	kom	640031	0 ⁴² €	317 ^{kn}

Šarnir spojnica

dimenzija	JM	Šifra art.	Cijena sa PDV-om	
50x50mm	kom	640033	0 ⁹² €	6 ⁹² kn

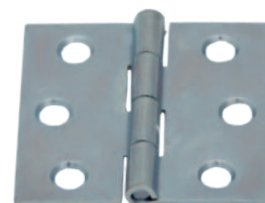
Šarnir spojnica

dimenzija	JM	Šifra art.	Cijena sa PDV-om	
40x40mm	kom	640032	0 ⁹⁰ €	6 ⁸⁰ kn

Šarnir spojnica

dimenzija	JM	Šifra art.	Cijena sa PDV-om	
60x60mm	kom	640034	0 ⁹⁸ €	7 ³⁸ kn

Šarnir spojnica

dimenzija	JM	Šifra art.	Cijena sa PDV-om	
70x70mm	kom	640035	146€	1100kn

Šarnir spojnica

dimenzija	obrada	JM	Šifra art.	Cijena sa PDV-om	
50x31mm	inox	kom	640049	294€	2217kn

Šarnir dugi[DO ISTEKA ZALIHA!](#)

dimenzija	JM	Šifra art.	Cijena sa PDV-om	
36x175mm	kom	640054	152€	1142kn
36x225mm	kom	640056	236€	1779kn
36x250mm	kom	640057	169€	1274kn

Kutnik

2,5ZN



dimenzija	JM	Šifra art.	Cijena sa PDV-om	
40x40x55mm	kom	070882	080€	606kn
60x60x55mm	kom	070883	134€	1007kn

Šarnir spojnica[DO ISTEKA ZALIHA!](#)

dimenzija	JM	Šifra art.	Cijena sa PDV-om	
100x100mm	kom	640038	171€	1288kn

Šarnir norma L[DO ISTEKA ZALIHA!](#)

dimenzija	JM	Šifra art.	Cijena sa PDV-om	
40x38mm	kom	640050	119€	900kn

Kutnik 4l - dupli

dimenzija	JM	Šifra art.	Cijena sa PDV-om	
21x21x37mm	kom	070841	015€	110kn

Kutnikmetalni
debljine 2,5mm

dimenzija	JM	Šifra art.	Cijena sa PDV-om	
32x32x40mm	kom	740005	049€	369kn

Kutnici

Kutnik



dimenzija	debljina	materijal	JM	Šifra art.	Cijena sa PDV-om	
37x37x35	2mm	metal	kom	740006	042€	316kn

Kutnik



dimenzija	JM	Šifra art.	Cijena sa PDV-om	
28x38x23mm	kom	190011	022€	167kn

Kutnik

Materijal: željezo
Obrada: pocinčan

emuca



dimenzija	JM	Šifra art.	Cijena sa PDV-om	
42x42	kom	820166	031€	233kn

Kutnik



dimenzija	JM	Šifra art.	Cijena sa PDV-om	
30x30x15mm	kom	190018	018€	135kn

Kutnik



dimenzija	debljina	materijal	JM	Šifra art.	Cijena sa PDV-om	
30x30x15	2,5mm	metal	kom	780062	017€	125kn

Kutnik 2L mali



dimenzija	JM	Šifra art.	Cijena sa PDV-om	
20x20x15mm	kom	070840	014€	105kn

Metalni kutnik

2mm



dimenzija	JM	Šifra art.	Cijena sa PDV-om	
40x40x15	2mm kom	071160	017€	131kn
50x50x15	2mm kom	071161	019€	143kn
60x60x15	2mm kom	071162	022€	163kn
70x70x15	2mm kom	071163	026€	197kn
80x80x15	2mm kom	071164	032€	243kn
90x90x15	2mm kom	071165	036€	268kn

Metalna pločica ravna

2mm



dimenzija	JM	Šifra art.	Cijena sa PDV-om	
60x15	2mm kom	071154	018€	135kn
80x15	2mm kom	071155	019€	143kn
120x15	2mm kom	071157	022€	167kn
160x15	2mm kom	071158	032€	242kn

Spojni okov

Vezna pločica 4L

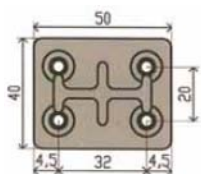

dimenzija	JM	Šifra art.	Cijena sa PDV-om	
50x40x1	kom	070884	021€	159kn

Spojni okov

PVC

[cent = 100kom](#)



bijela siva

dimenzija	obrada	JM	Šifra art.	Cijena sa PDV-om	
21x20x34mm	bijela	cent	740008	1075€	8100kn
21x20x34mm	siva	cent	740009	1075€	8100kn

PVC držač lesonita s vijkom

[cent = 100kom](#)



JM	Šifra art.	Cijena sa PDV-om	
cent	740015	64€	5000kn

Spojni kut

Sa zaklopkom i 2 upuštena provrta
Ø 4,5mm

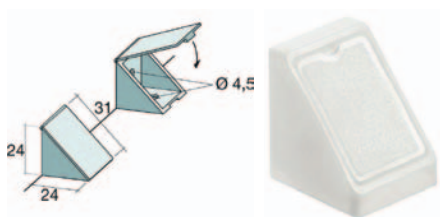

JM	Šifra art.	Cijena sa PDV-om	
24x24x3mm	kom	501221	015€ 113kn

Spojni, sitni i nosivi okov

Kutnik



dimenzija	JM	Šifra art.	Cijena sa PDV-om	
50x50mm	kom	090059	048€	365kn

Spojni okov

Pričvršćivanje vijcima za ivericu s upuštenom glavom Ø 3,5 – 4mm
Uključene pokrivne kapice za vijke



bijela svijetlo smeđa tamno smeđa

dimenzija	obrada	JM	Šifra art.	Cijena sa PDV-om	
21x21x44mm	bijela	kom	501450	021€	155kn
21x21x44mm	svijetlo smeđa	kom	501451	021€	158kn
21x21x44mm	tamno smeđa	kom	501452	021€	158kn

Spojni okov pvc mali

[cent = 100kom](#)



obrada	JM	Šifra art.	Cijena sa PDV-om	
21x20x24mm	bijela	cent	740012	88€ 6700kn

Kutnik mali + pokrov bijeli



JM	Šifra art.	Cijena sa PDV-om	
kom	650038	058€	435kn

Spojni okov

Okov pločica

1 rupa za ključ
Pocinčani čelik



dimenzija	JM	Šifra art.	Cijena sa PDV-om	
70x18x3mm	kom	501232	1 ⁵⁹ €	11 ⁹⁸ kn

Učvršne pločice za leđa ormara (lesonita)

Neobrađeni čelik

[cent = 100kom](#)



dimenzija	JM	Šifra art.	Cijena sa PDV-om	
17x16x1mm	cent	500804	13 ⁰¹ €	98 ⁰⁰ kn

Element za spajanje stranica korpusa pomoću vijaka

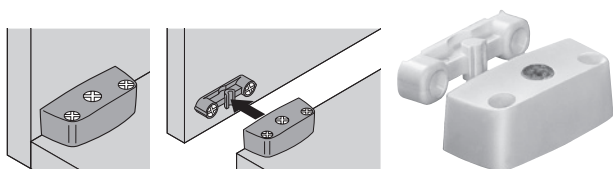

materijal/obrada	JM	Šifra art.	Cijena sa PDV-om	
PVC, bijeli	kom	070490	0 ⁵⁰ €	37 ⁵ kn
PVC, smeđi	kom	070474	0 ⁵⁰ €	37 ⁵ kn

K-lock magnet + pločica **DO ISTEKA ZALIHAI!**

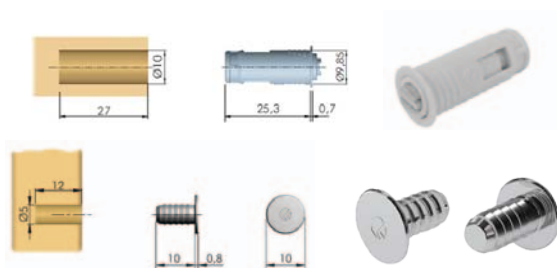

JM	Šifra art.	Cijena sa PDV-om	
kom	070961	2 ⁶⁵ €	19 ⁹⁵ kn

Zaskočna pločica s 1 rupom



dimenzija	JM	Šifra art.	Cijena sa PDV-om	
	kom	650026	0 ⁴⁰ €	2 ⁹⁸ kn

Nevidljiva britvela



ø	kut otvaranja	obrada	JM	Šifra art.	Cijena sa PDV-om	
10mm	180°	sjajni mesing	kom	500277	4 ⁵⁸ €	34 ⁵¹ kn
12mm	180°	sjajni mesing	kom	500278	4 ¹⁹ €	31 ⁵⁹ kn
14mm	180°	sjajni mesing	kom	500279	5 ⁶² €	42 ³⁶ kn

Spojница za staklo

4-6mm



	obrada	JM	Šifra art.	Cijena sa PDV-om	
pocinčani čelik	krom	kom	500510	2 ⁹⁷ €	22 ³⁷ kn

Prihvata "QUICK"

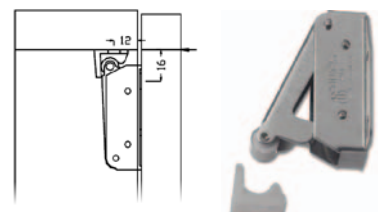

JM	Šifra art.	Cijena sa PDV-om	
kom	500333	6 ³⁹ €	48 ¹⁷ kn

Zaskočnik



	JM	Šifra art.	Cijena sa PDV-om	
	kom	650027	128€	965kn

Magnet 3kg

3,2kg

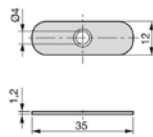
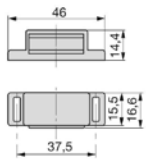

	JM	Šifra art.	Cijena sa PDV-om	
magnet bijeli bez podl.	kom	8201670	039€	292kn
podloška	kom	8201671	006€	047kn

Vijak za spoj M6

[cent = 100kom](#)



	mm		JM	Šifra art.	Cijena sa PDV-om	
M6	70	brunirani čelik	cent	500207	2243€	16900kn

Vijak M6

d1: 6mm; L: 12mm; d2: 12mm; k max.: 4,6mm

[cent = 100kom](#)



		JM	Šifra art.	Cijena sa PDV-om	
M6x12	Prihvat PH 3	cent	070765	518€	3900kn

Magnet 5kg



	JM	Šifra art.	Cijena sa PDV-om	
bijeli	kom	650001	107€	806kn
smeđi	kom	650002	107€	806kn

Kuglični držač vrata

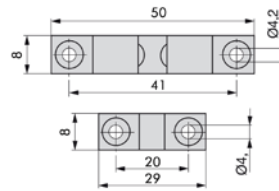

	JM	Šifra art.	Cijena sa PDV-om	
	kom	820038	318€	2396kn

Matica za spoj M6

Duljina 12,5mm, Razmak 5mm

[cent = 100kom](#)



	ø mm		JM	Šifra art.	Cijena sa PDV-om	
M6	70	Glatko željezo	cent	500209	1526€	11500kn

Šajba za spoj

[cent = 100kom](#)



ø mm		JM	Šifra art.	Cijena sa PDV-om	
13	Brunirani čelik	cent	500208	7259€	5469kn

Spojni okov

Vezni vijak M6

Čahura duga

JM cent = 100kom

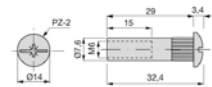
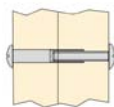
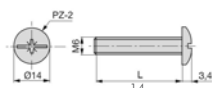

Ø			JM	Šifra art.	Cijena sa PDV-om	
	M6	Vijak bez matice	cent	5000380	9 ⁵⁵ €	71% ^{kn}
7,6	M6	Matica	cent	5000381	24 ⁵⁶ €	185 ⁰⁴ kn

PVC matica M6

JM cent = 100kom



	JM	Šifra art.	Cijena sa PDV-om	
Ø10x13	cent	650021	8 ³¹ €	62 ⁶⁴ kn
Ø10x11	cent	650022	6 ⁵⁹ €	49 ⁶⁸ kn

Trio matica

JM cent = 100kom



dimenzija	JM	Šifra art.	Cijena sa PDV-om	
M8 # 15	cent	501462	23 ⁸⁹ €	180 ⁰⁰ kn

Unit matica

JM cent = 100kom



	JM	Šifra art.	Cijena sa PDV-om	
M4	cent	2403010037	8 ⁸⁰ €	66 ³⁰ kn
M5	cent	2403010039	10 ⁶⁰ €	79 ⁸⁷ kn
M6	cent	2403010026	7 ⁹⁹ €	60 ²⁰ kn
M8	cent	2403010027	14 ⁴⁷ €	109 ⁰² kn
M10	cent	2403010038	22 ³⁰ €	168 ⁰² kn

Vezni vijak M4

JM cent = 100kom

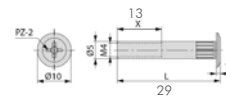
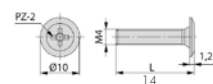

Ø mm			JM	Šifra art.	Cijena sa PDV-om	
	M4	Vijak bez matice	cent	0700150	49 ⁷ €	374 ⁴ kn
5	M4	Matica	cent	0700151	14 ¹⁴ €	106 ⁵⁶ kn

Matica ukopna M DO ISTEKA ZALIHA!

Sirovi čelik

JM cent = 100kom

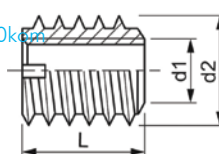

d1xLxd2	JM	Šifra art.	Cijena sa PDV-om	
4x8x8mm	cent	2403010040	35 ⁰⁴ €	264 ⁰⁰ kn
4x10x8mm	cent	2403010082	42 ⁰⁹ €	317 ¹³ kn
5x12x10mm	cent	500094	51 ¹⁰ €	385 ⁰⁰ kn
6x12x12mm	cent	500095	82 ¹⁹ €	619 ²⁶ kn

Tipla metalna M6

JM cent = 100kom



		JM	Šifra art.	Cijena sa PDV-om	
M6	10x13	cent	250001	22 ¹⁶ €	167 ⁰⁰ kn

Usadna matica

JM cent = 100kom



			JM	Šifra art.	Cijena sa PDV-om	
M8	18x10,7	Ø20	cent	820059	29 ³³ €	221 ⁰⁰ kn
M10	19x12,5	Ø22	cent	820065	36 ³⁷ €	274 ⁰⁰ kn

Spojni okov

Spojka

nikal



H mm		JM	Šifra art.	Cijena sa PDV-om	
14	Ø 20mm	kom	650019	0 ⁸³ €	6 ²⁵ kn

Vijak za fix spojku

[cent = 100kom](#)

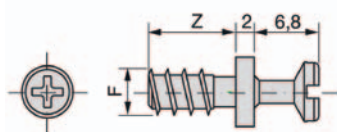

Z mm		JM	Šifra art.	Cijena sa PDV-om	
11	Ø 6mm	cent	820040	17 ⁹² €	135 ⁰⁰ kn

Excentar

[cent = 100kom](#)

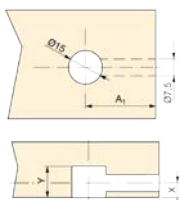

za	JM	Šifra art.	Cijena sa PDV-om	
12,5x16	cent	820063	9 ⁸² €	74 ⁰⁰ kn

Excentar Cam3000 Ø15

[cent = 100kom](#)



	JM	Šifra art.	Cijena sa PDV-om	
B15/16mm	cent	650007	11 ⁰² €	83 ⁰⁰ kn
B18/19mm	cent	650008	11 ⁵⁵ €	87 ⁰⁰ kn

Fix spojka

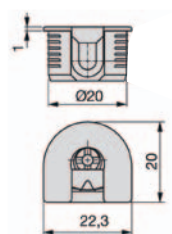

H mm		JM	Šifra art.	Cijena sa PDV-om	
14	Ø 20mm	kom	820039	0 ³⁶ €	27 ³ kn

Vijak za spojku

[cent = 100kom](#)



H mm		JM	Šifra art.	Cijena sa PDV-om	
11,5	Ø 5mm	cent	650020	11 ⁴⁷ €	86 ⁴⁰ kn

Šablonski čep za ladice

blum



	JM	Šifra art.	Cijena sa PDV-om	
19,8x10x1mm	kom	510177	2 ²⁹ €	17 ²⁸ kn

Stezni vijak za drvo

[cent = 100kom](#)

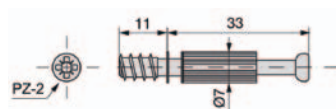

	JM	Šifra art.	Cijena sa PDV-om	
44mm	cent	820064	11 ⁴¹ €	86 ⁰⁰ kn

Steznik Combi

[cent = 100kom](#)

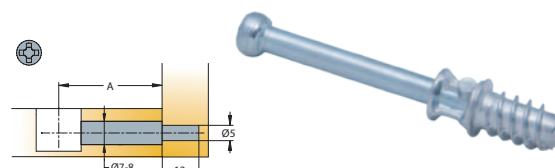

A	JM	Šifra art.	Cijena sa PDV-om		
34mm	Ø 5mm	cent	650015	11 ⁴¹ €	86 ⁰⁰ kn

Spojni okov

Steznik Combi

cent = 100kom

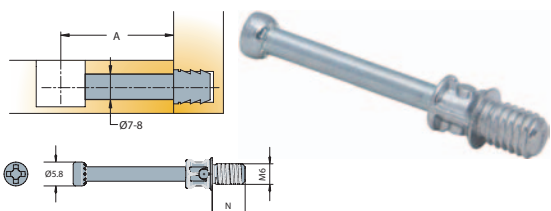

		JM	Šifra art.	Cijena sa PDV-om	
M6	Ø 5mm	cent	650016	995€	7500kn

Steznik

međustranica B=18mm

S osiguračem

cent = 100kom

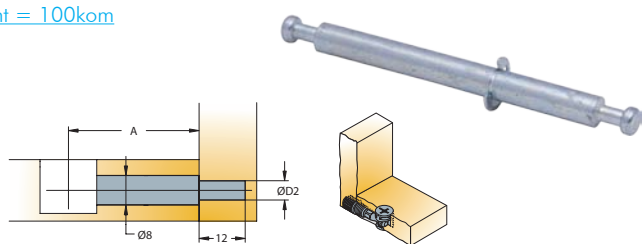

	JM	Šifra art.	Cijena sa PDV-om	
Ø 8mm	cent	650018	7669€	57780kn

Nosač polica

cent = 100kom

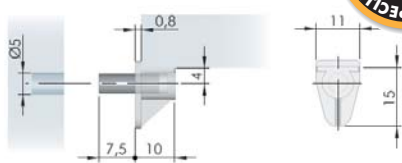

bijela transp.

boja	JM	Šifra art.	Cijena sa PDV-om	
bijela	cent	820119	79€	6000kn
transparentna	cent	820120	79€	6000kn

Uložni nosač police s prstenom

cent = 100kom

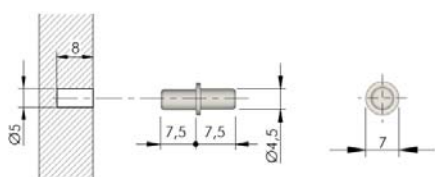

Ø		JM	Šifra art.	Cijena sa PDV-om	
5mm	željezo poniklano	cent	070714	425€	3200kn

Quickfit

cent = 100kom

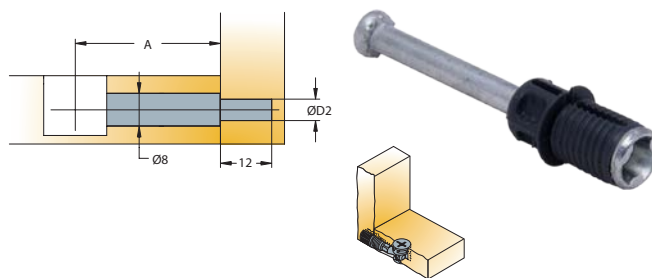

A		JM	Šifra art.	Cijena sa PDV-om	
34mm	Ø 8mm	cent	650017	1380€	10400kn

Podešivač fronte

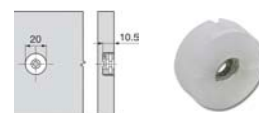

	JM	Šifra art.	Cijena sa PDV-om	
M4 x 20mm	kom	501499	044€	329kn

Podešivač fronte



obrada	JM	Šifra art.	Cijena sa PDV-om	
naturalna	kom	510592	036€	269kn

Nosač police s čavličem

cent = 100kom



boja	JM	Šifra art.	Cijena sa PDV-om	
bijela	cent	501601	1020€	7685kn
smeđa	cent	501602	1020€	7685kn
krem	cent	501603	1020€	7685kn

Nosač polica DO ISTEKA ZALIHA!

Ø 5mmx24

cent = 100kom



bijeli cink crni cink žuti cink

boja	JM	Šifra art.	Cijena sa PDV-om	
bijeli cink (M&M SPEC)	cent	550712	420€	3164kn
crni cink	cent	071134	677€	5100kn
žuti cink	cent	071135	425€	3200kn

Spojni okov

Nosač police u obliku žice

cent = 100kom



Ø		JM	Šifra art.	Cijena sa PDV-om	
5mm	željezo niklano	cent	501291	876€	6600kn

Nosač staklenih polica ravni



Ø mm		JM	Šifra art.	Cijena sa PDV-om	
5		kom	550402	037€	281kn

Nosač staklenih polica



obrada		JM	Šifra art.	Cijena sa PDV-om	
krom		kom	090055	167€	1260kn

X-Držać za ogledalo

DO ISTEKA ZALIHA!



set		JM	Šifra art.	Cijena sa PDV-om	
4kom	krom	set	070959	374€	2820kn

Spojni, sitni i nosivi okov

Nosač staklene police

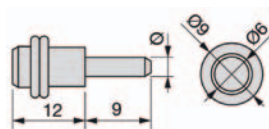

Ø mm	obrada	JM	Šifra art.	Cijena sa PDV-om	
5	nikal	kom	820129	053€	402kn

Kapica za ogledalo

sastoji se iz dva dijela: podloška za vijak i kapice mesing poniklani



		JM	Šifra art.	Cijena sa PDV-om	
Ø 19mm		kom	501197	070€	527kn

Držać za staklo



		JM	Šifra art.	Cijena sa PDV-om	
		kom	501226	026€	193kn

Kuke za sliku

DO ISTEKA ZALIHA!



			JM	Šifra art.	Cijena sa PDV-om	
N.1	10	pak		640063	091€	687kn
N.2	10	pak		640064	108€	813kn

Trokuti za sliku
DO ISTEKA ZALIHA!



	pak/kom	JM	Šifra art.	Cijena sa PDV-om	
N.1	21	pak	640059	197€	1488kn
N.2	18	pak	640060	197€	1488kn
N.3	15	pak	640061	197€	1488kn

Zidna kuka

cent = 100kom



		JM	Šifra art.	Cijena sa PDV-om	
Zn	50mm	cent	640015	1460€	11000kn
Zn	60mm	cent	640016	3384€	25500kn
Zn	70mm	cent	640017	3451€	26000kn
Zn	80mm	cent	640018	3650€	27500kn

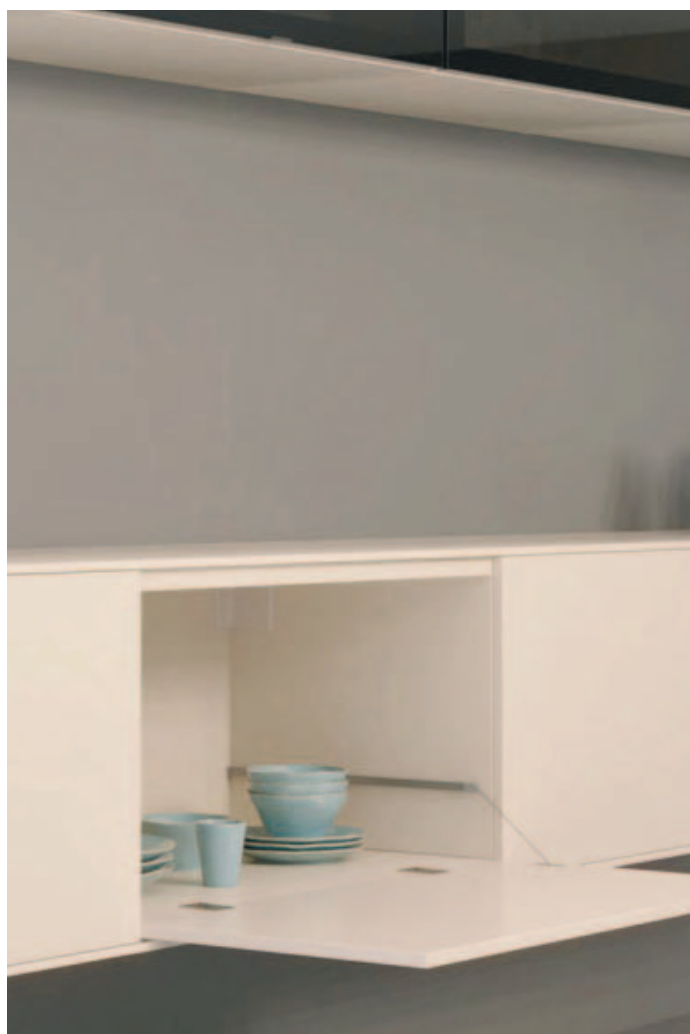

Zidna kuka

DO ISTEKA ZALIHA!

cent = 100kom



		JM	Šifra art.	Cijena sa PDV-om	
Zn	30mm	cent	640008	1739€	13100kn
Zn	40mm	cent	640009	1885€	14200kn
Zn	50mm	cent	640010	4327€	32600kn
Zn	7x80mm	cent	640014	10273€	77400kn

Libra nosač visećih elemenata



set dva nosača:
lijevi + desni

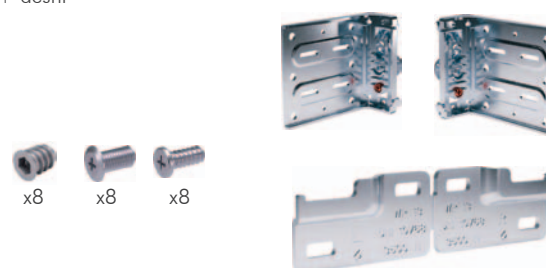

			JM	Šifra art.	Cijena sa PDV-om	
lijevi + desni	126kg	nosivost	set	312013	1320€	9943kn

Libra pokrivna kapa bijela



	obrada	JM	Šifra art.	Cijena sa PDV-om	
lijeva	bijela	kom	312014	055€	411kn
desna	bijela	kom	312015	055€	411kn

Libra pokrivna kapa antracit



	obrada	JM	Šifra art.	Cijena sa PDV-om	
lijeva	antracit	kom	312016	055€	411kn
desna	antracit	kom	312017	055€	411kn

Nosač visećih elemenata



Ø	obrada	JM	Šifra art.	Cijena sa PDV-om	
35mm	metalni	kom	501616	070€	531kn

Nosač lam.



gar	obrada	JM	Šifra art.	Cijena sa PDV-om	
4kom	bijela	gar	070855	307€	2310kn
4kom	smeđa	gar	070856	338€	2544kn

Nosač elemenata mali



debljina	obrada	JM	Šifra art.	Cijena sa PDV-om	
1,2mm	bijeli PVC+metal	kom	740022	035€	263kn

Nosač za element - ovjes ormara

Horizontalna podesivost: 25mm
 Vertikalna podesivost: 28 mm



	nosivost	JM	Šifra art.	Cijena sa PDV-om	
desni	50kg	kom	5002660	111€	838kn
lijevi	50kg	kom	5002661	111€	838kn

Nosač visećih elemenata L



debljina	obrada	JM	Šifra art.	Cijena sa PDV-om	
1,5mm	bijeli PVC+metal	kom	740021	061€	462kn

Ukras za ovjes ormara

Pokrivna kapa

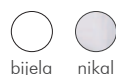
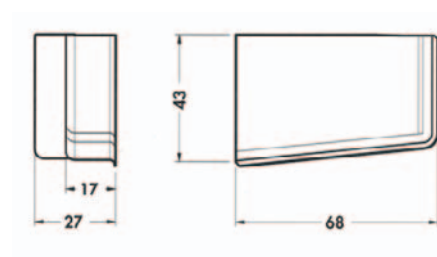

obrada	JM	Šifra art.	Cijena sa PDV-om	
PVC, bijela, desna	kom	5002670	025€	187kn
PVC, bijela, lijeva	kom	5002671	025€	187kn
metalna, nikl, desna	kom	5002680	044€	333kn
metalna, nikl, lijeva	kom	5002681	044€	333kn

Šina



visina	dužina	JM	Šifra art.	Cijena sa PDV-om	
27mm	2032mm	kom	500274	674€	5075kn

Šina za vješanje visećih elemenata

GTV

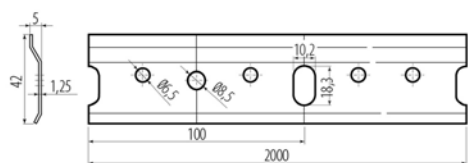

duljina mm		JM	Šifra art.	Cijena sa PDV-om	
2000	čelik	kom	090176	10 ¹³ €	76 ³⁵ kn

Nosač staklene police za ploču



	JM	Šifra art.	Cijena sa PDV-om	
200mm	kom	501645	11 ¹² €	83 ⁸¹ kn

Skriveni nosač polica

ITALIANA
TERRAMARCA

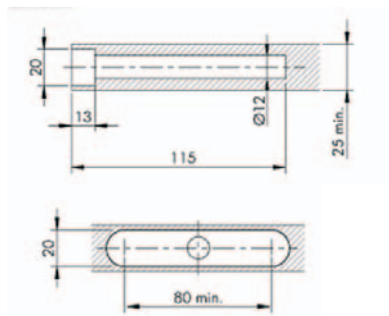

Dimenzija	JM	Šifra art.	Cijena sa PDV-om	
76x110	kom	501751	11 ³ €	84 ⁸ kn

Zidni nosač

bijeli jednostruki



	JM	Šifra art.	Cijena sa PDV-om	
23x500x2mm	kom	123001	36 ⁷ €	276 ⁸ kn
23x1000x2mm	kom	123002	74 ¹ €	558 ⁰ kn
23x2000x2mm	kom	123003	109 ⁹ €	827 ⁹ kn

Nosač staklene police za zid

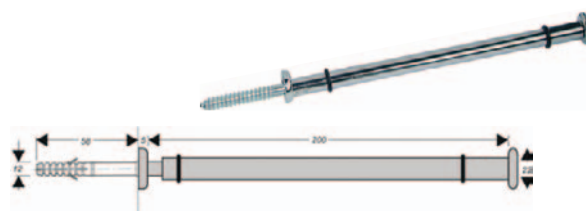

	JM	Šifra art.	Cijena sa PDV-om	
200mm	kom	501644	19 ⁷⁰ €	148 ⁴⁴ kn

Nosač pvc za ukopne police



	JM	Šifra art.	Cijena sa PDV-om	
10-100	kom	090180	24 ⁰ €	181 ⁰ kn
12-120	kom	070838	24 ³ €	183 ⁰ kn
14-140	kom	070839	34 ⁵ €	259 ⁸ kn
14-165	kom	550478	35 ⁰ €	264 ⁰ kn

Nosač polica s vijkom



	JM	Šifra art.	Cijena sa PDV-om	
12x120mm	kom	501498	33 ⁸ €	255 ⁰ kn

Konzola preklopna

materijal: čelik

obrada: bijeli cink

kut otvaranja: 70°, 80°, 90°

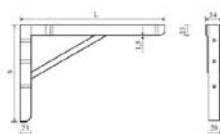

Dužina (l)	Visina (h)	Nosivost	JM	Šifra art.	Cijena sa PDV-om	
300mm	200mm	80kg	kom	071189	187 ⁷ €	1414 ⁶ kn
400mm	250mm	70kg	kom	071190	290 ³ €	2186 ⁹ kn

Konzola za policu



	JM	Šifra art.	Cijena sa PDV-om	
80x120 bijela	kom	501631	313€	23 ⁵⁵ kn
120x170 bijela	kom	501632	385€	29 ⁰¹ kn
155x220 bijela	kom	501633	472€	35 ⁶⁰ kn
190x270 bijela	kom	501634	655€	49 ³⁶ kn
80x120 siva	kom	501635	433€	32 ⁵⁹ kn
120x170 siva	kom	501636	566€	42 ⁶⁴ kn
155x220 siva	kom	501637	569€	42 ⁸⁷ kn
190x270 siva	kom	501638	565€	42 ⁵⁷ kn

Nosač polica



	obrada	JM	Šifra art.	Cijena sa PDV-om	
100x125	bijela	kom	640020	075€	5 ⁶⁴ kn
150x200	bijela	kom	640021	147€	11 ⁰⁸ kn
200x250	bijela	kom	640022	203€	15 ²⁷ kn
250x300	bijela	kom	640023	268€	20 ²⁰ kn
300x350	bijela	kom	640024	430€	32 ⁴¹ kn



Spojni, sitni i nosivi okov

L-konzola

jednostruka bijela



	JM	Šifra art.	Cijena sa PDV-om	
170x1,5mm D	kom	123004	268€	20 ²¹ kn
170x1,5mm L	kom	123005	268€	20 ²¹ kn
270x1,5mm D	kom	123006	323€	24 ³¹ kn
270x1,5mm L	kom	123007	323€	24 ³¹ kn
370x1,5mm D	kom	123008	471€	35 ⁵¹ kn
370x1,5mm L	kom	123009	471€	35 ⁵¹ kn

Nosač polica

DO ISTEKA ZALIHA!



	obrada	JM	Šifra art.	Cijena sa PDV-om	
200x250	smeđa	kom	640027	149€	11 ²³ kn

Nosač polica BAR

materijal: čelik



dimenzija	opteretivost	obrada	JM	Šifra art.	Cijena sa PDV-om	
20x16cm	20kg	crni mat	kom	090402	416€	31 ³¹ kn

Nosači

Nosač polica BELT

materijal: čelik

GTV



dimenzija	opteretivost	obrada	JM	Šifra art.	Cijena sa PDV-om	
23x22cm	30kg	crni mat	kom	090403	773€	5826kn

Nosač polica GALA

materijal: čelik

GTV



dimenzija	opteretivost	obrada	JM	Šifra art.	Cijena sa PDV-om	
25x22cm	30kg	crni mat	kom	090405	513€	3865kn

Nosač polica INGRID

materijal: čelik

GTV



dimenzija	opteretivost	obrada	JM	Šifra art.	Cijena sa PDV-om	
23x26cm	20kg	crni mat	kom	090407	786€	5922kn

Nosač polica ROD

materijal: čelik

GTV



dimenzija	opteretivost	obrada	JM	Šifra art.	Cijena sa PDV-om	
21x16cm	20kg	crni mat	kom	090409	481€	3624kn

Nosač polica FLAT

materijal: čelik

GTV



dimenzija	opteretivost	obrada	JM	Šifra art.	Cijena sa PDV-om	
20x20cm	15kg	crni mat	kom	090404	405€	3050kn

Nosač polica GINO

materijal: čelik

GTV



dimenzija	opteretivost	obrada	JM	Šifra art.	Cijena sa PDV-om	
30x20cm	30kg	crni mat	kom	090406	823€	6201kn

Nosač polica NEO

materijal: čelik

GTV



dimenzija	opteretivost	obrada	JM	Šifra art.	Cijena sa PDV-om	
18x18cm	20kg	crni mat	kom	090408	634€	4780kn

Nosač polica TREE

materijal: čelik

GTV



dimenzija	opteretivost	obrada	JM	Šifra art.	Cijena sa PDV-om	
17x20cm	20kg	crni mat	kom	090410	662€	4988kn

Nosači

Nosač polica WIRE

materijal: čelik



dimenzija	opteretivost	obrada	JM	Šifra art.	Cijena sa PDV-om	
18x16cm	30kg	crni mat	kom	090411	714€	53 ⁸⁰ kn

Konzola 85kg



	JM	Šifra art.	Cijena sa PDV-om	
210x295 bijela	kom	501639	22 ⁸⁶ €	172 ²⁶ kn
270x395 bijela	kom	501640	18 ³⁸ €	138 ⁴⁸ kn
330x495 bijela	kom	501641	18 ⁶⁰ €	140 ¹⁵ kn

Nosač police

Debljina materijala: 4-26mm

Nosivost: 5kg



	obrada	JM	Šifra art.	Cijena sa PDV-om	
42x43mm	inox sat.	kom	501663	8 ⁰⁸ €	60 ⁸⁹ kn
42x43mm	mat krom lak	kom	501665	8 ²⁷ €	62 ³¹ kn

Nosač police pelikan mini

Materijal : ZnAl

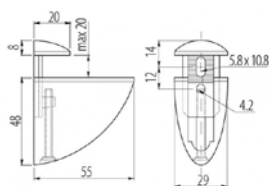

obrada	debljina hvata max	JM	Šifra art.	Cijena sa PDV-om	
satin	20mm	kom	090266	3 ⁸⁸ €	29 ²⁴ kn
mat krom	20mm	kom	090267	3 ⁸⁸ €	29 ²⁴ kn

Sistem za police

[DO ISTEKA ZALIHA!](#)

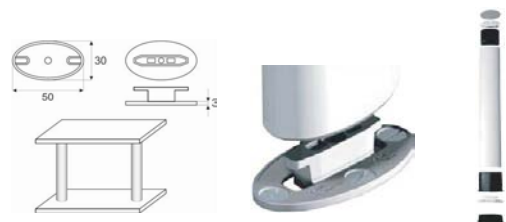

	JM	Šifra art.	Cijena sa PDV-om	
ovalna cijev 2m, alu	kom	070845	37 ⁹⁰ €	285 ⁵⁴ kn
ovalni čep za pod	kom	070846	2 ⁴⁴ €	18 ⁴² kn
ovalna pločica i čep	kom	070847	6 ⁵⁴ €	49 ³⁰ kn

Zidni nosač Pelikan

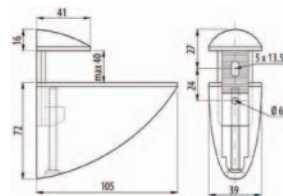

obrada	nosivost max	debljina hvata max	JM	Šifra art.	Cijena sa PDV-om	
nikal sat	12kg	40mm	kom	090077	10 ⁸⁹ €	82 ⁰⁵ kn
alu	12kg	40mm	kom	090078	10 ⁸⁹ €	82 ⁰⁵ kn

Nosač police GS04

Materijal : ZnAl

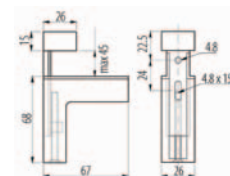

obrada	debljina hvata max	JM	Šifra art.	Cijena sa PDV-om	
mat krom	45mm	kom	090268	7 ⁸² €	58 ⁸⁹ kn
satin	45mm	kom	090269	7 ⁸² €	58 ⁸⁹ kn
krom	45mm	kom	090270	7 ⁸² €	58 ⁸⁹ kn



Nosač za staklene police Grace

5-6 mm



Nosač za staklene police Kalabrone mini

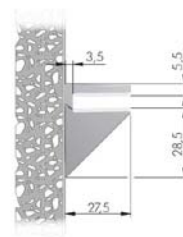
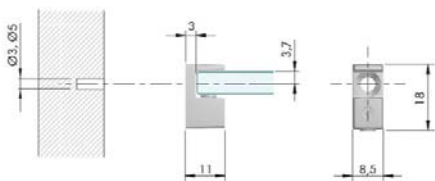

materijal, obrada	JM	Šifra art.	Cijena sa PDV-om	
crni nickel	kom	312032	064€	482kn

materijal, obrada	JM	Šifra art.	Cijena sa PDV-om	
crni mat	kom	312033	317€	2388kn

Klin za namještaj

[cent = 100kom](#)



obrada	JM	Šifra art.	Cijena sa PDV-om	
bijela	cent	040259	650€	4900kn
smeđa	cent	040281	650€	4900kn

Kajlica PVC - penula

[cent = 100kom](#)



obrada	JM	Šifra art.	Cijena sa PDV-om	
bijela	cent	650030	1208€	9100kn
smeđa	cent	650031	1354€	10200kn

Kajlica drvena - penula

[cent = 100kom](#)



obrada	JM	Šifra art.	Cijena sa PDV-om	
drvo	cent	500031	4442€	33465kn

Podloga ovalna

[cent = 100kom](#)



dim	JM	Šifra art.	Cijena sa PDV-om	
38x18mm	cent	500801	10352€	78000kn

Filc s čavličem

[cent = 100kom](#)



	obrada	JM	Šifra art.	Cijena sa PDV-om	
Ø15 x 8mm	smeđi	cent	071173	16 ⁹⁹ €	128 ⁰⁰ kn

Filc s čavličem DO ISTEKA ZALIHA!

[cent = 100kom](#)



	obrada	JM	Šifra art.	Cijena sa PDV-om	
Ø17	bijela	cent	071174	44 ⁰⁶ €	332 ⁰⁰ kn
Ø17	smeđa	cent	071175	38 ³⁶ €	289 ⁰⁰ kn
Ø25	bijela	cent	071176	41 ⁰¹ €	309 ⁰⁰ kn

Odbojnik samoljepljivi okrugli

Prodaja na 0,5cent (50kom=1 listić)

[cent = 100kom](#)



	JM	Šifra art.	Cijena sa PDV-om	
Ø = 10mm	cent	070707	6 ⁶⁴ €	50 ⁰¹ kn

Ublaživač



	JM	Šifra art.	Cijena sa PDV-om	
Ø 19mm	9,6mm kom	070859	1 ⁵⁴ €	11 ⁵⁸ kn

Podloška s čavličem

[cent = 100kom](#)

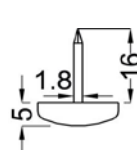

	JM	Šifra art.	Cijena sa PDV-om	
Ø15mm	cent	501611	4 ⁵¹ €	34 ⁰⁰ kn

Filc samoljepljivi okrugli



Ø/pak(kom)/boja	debljina mm	JM	Šifra art.	Cijena sa PDV-om	
20mm/44/smeđi	3,5	pak	071169	1 ³⁰ €	97 ⁹ kn
22mm/40/smeđi	3,5	pak	071171	1 ²⁸ €	9 ⁶⁸ kn
28mm/24/smeđi	3,5	pak	0711720	0 ⁹⁶ €	7 ²³ kn

Ublaživač ukopni

12,5mm



	JM	Šifra art.	Cijena sa PDV-om	
Ø = 8mm	12,5mm kom	070834	0 ¹⁹ €	1 ⁴³ kn

Samoljepljivi stoper za vrata



Ø	obrada	JM	Šifra art.	Cijena sa PDV-om	
40mm	bijela	kom	071184	2 ¹¹ €	15 ⁸⁸ kn
40mm	smeđa	kom	071185	1 ⁹² €	14 ⁴⁴ kn

Odbojnik samoljepljivi

cent = 100kom

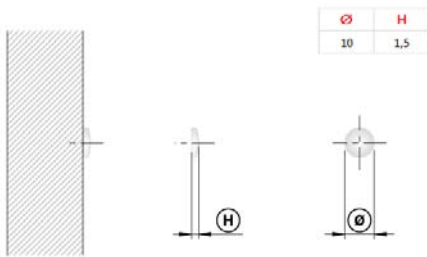

Ø	H	materijal	JM	Šifra art.	Cijena sa PDV-om	
10	1,5	PVC	cent	312031	346€	2607kn

Odbojnik za vrata

cent = 100kom

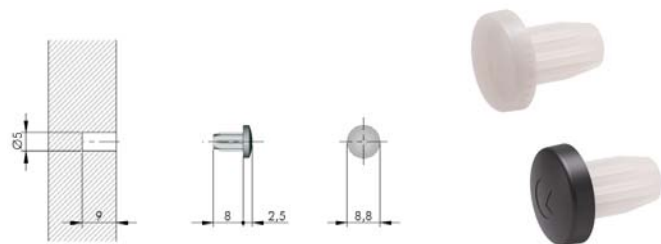

Ø	H	g	Ø	obrada	materijal	JM	Šifra art.	Cijena sa PDV-om	
5mm	8	2,5	8,8	bijela	PVC	cent	501299	757€	5700kn
5mm	8	2,5	8,8	crna	PVC	cent	312030	763€	5750kn

Odbojnik za kvaku transparentni

način pričvršćivanja: za naticanje na kvaku
materijal: guma

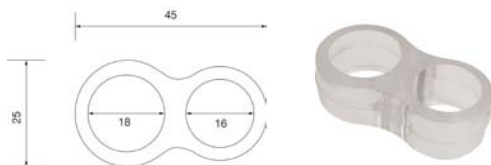

dimenzija	obrada	JM	Šifra art.	Cijena sa PDV-om	
45x25x13mm	transparentna	kom	501725	026€	199kn

Odbojnik za sobna vrata



	JM	Šifra art.	Cijena sa PDV-om	
TS 8 G, sivi	kom	501565	491€	3699kn
TS 8 W, bijeli	kom	501566	491€	3699kn
TS 8 S, crni	kom	501567	491€	3699kn
TS 8 BR, smeđi	kom	501568	491€	3699kn

PVC kapica

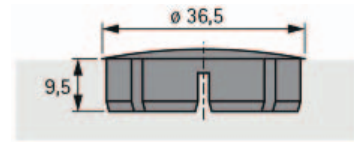

obrada	JM	Šifra art.	Cijena sa PDV-om	
bijela	kom	500029	091€	689kn
smeđa	kom	501598	085€	641kn

Pokrivna naljepnica

kom = listić



kom = listić

boja	Ø	listić/ kom	JM	Šifra art.	Cijena sa PDV-om	
bijela	13	20/1	kom	820138	075€	563kn
bijela	20	15/1	kom	820139	124€	938kn
smeđa	13	20/1	kom	820147	075€	563kn
crna	13	20/1	kom	820148	075€	563kn
pepeljasta	13	20/1	kom	820149	075€	563kn
hrast	13	20/1	kom	820150	075€	563kn
siva	13	20/1	kom	820151	075€	563kn
bež	13	20/1	kom	820152	075€	563kn
trešnja	13	20/1	kom	820153	075€	563kn
bukva	13	20/1	kom	820154	075€	563kn
bor	13	20/1	kom	820155	075€	563kn
wenge	13	20/1	kom	820156	075€	563kn
smeđa	20	15/1	kom	820157	124€	938kn
crna	20	15/1	kom	820158	124€	938kn
pepeljasta	20	15/1	kom	820159	124€	938kn
hrast	20	15/1	kom	820160	124€	938kn
siva	20	15/1	kom	820161	124€	938kn
bež	20	15/1	kom	820162	124€	938kn
trešnja	20	15/1	kom	820163	124€	938kn
bukva	20	15/1	kom	820164	124€	938kn
wenge	20	15/1	kom	820165	124€	938kn

Pokrivna kapica HEX

[cent = 100kom](#)

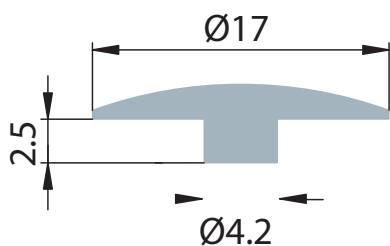

obrada	JM	Šifra art.	Cijena sa PDV-om	
krem	cent	650009	252€	1900kn
bijela	cent	650010	252€	1900kn
bež	cent	650011	252€	1900kn
smeđa	cent	650012	252€	1900kn
siva	cent	650013	252€	1900kn
crna	cent	650014	252€	1900kn

Lamela 20

[cent = 100kom](#)



JM	Šifra art.	Cijena sa PDV-om	
cent	070772	37€	2800kn

Pokrivna kapica DO ISTEKA ZALIHA!

[cent = 100kom](#)



	JM	Šifra art.	Cijena sa PDV-om	
Ø10mm; bijela	cent	070021	571€	4300kn
Ø10mm; smeđa	cent	070092	571€	4300kn
Ø12mm; bijela	cent	501673	518€	3900kn
Ø12mm; smeđa	cent	501674	518€	3900kn

Pokrivna kapica

[cent = 100kom](#)



	JM	Šifra art.	Cijena sa PDV-om	
10mm pvc alu	cent	501539	518€	3900kn

Drveni tipli



	JM	Šifra art.	Cijena sa PDV-om	
6-30	kg	070226	1632€	12296kn
8-35	kg	070225	1314€	9904kn
10-35	kg	070962	874€	6585kn

Podloga za centriranje



	grt	JM	Šifra art.	Cijena sa PDV-om	
6mm	4kom	grt	640005	318€	2396kn
8mm	4kom	grt	640006	383€	2886kn
10mm	4kom	grt	640007	39€	2984kn

Okov za kompakt ploče

Okov za kompakt ploče

Okovi za kompakt su po narudžbi!!!

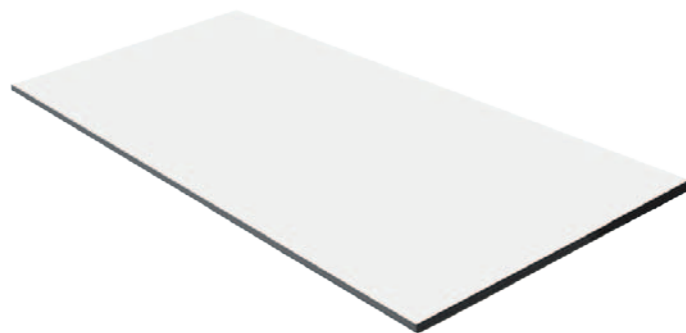

Primjer upotrebe:

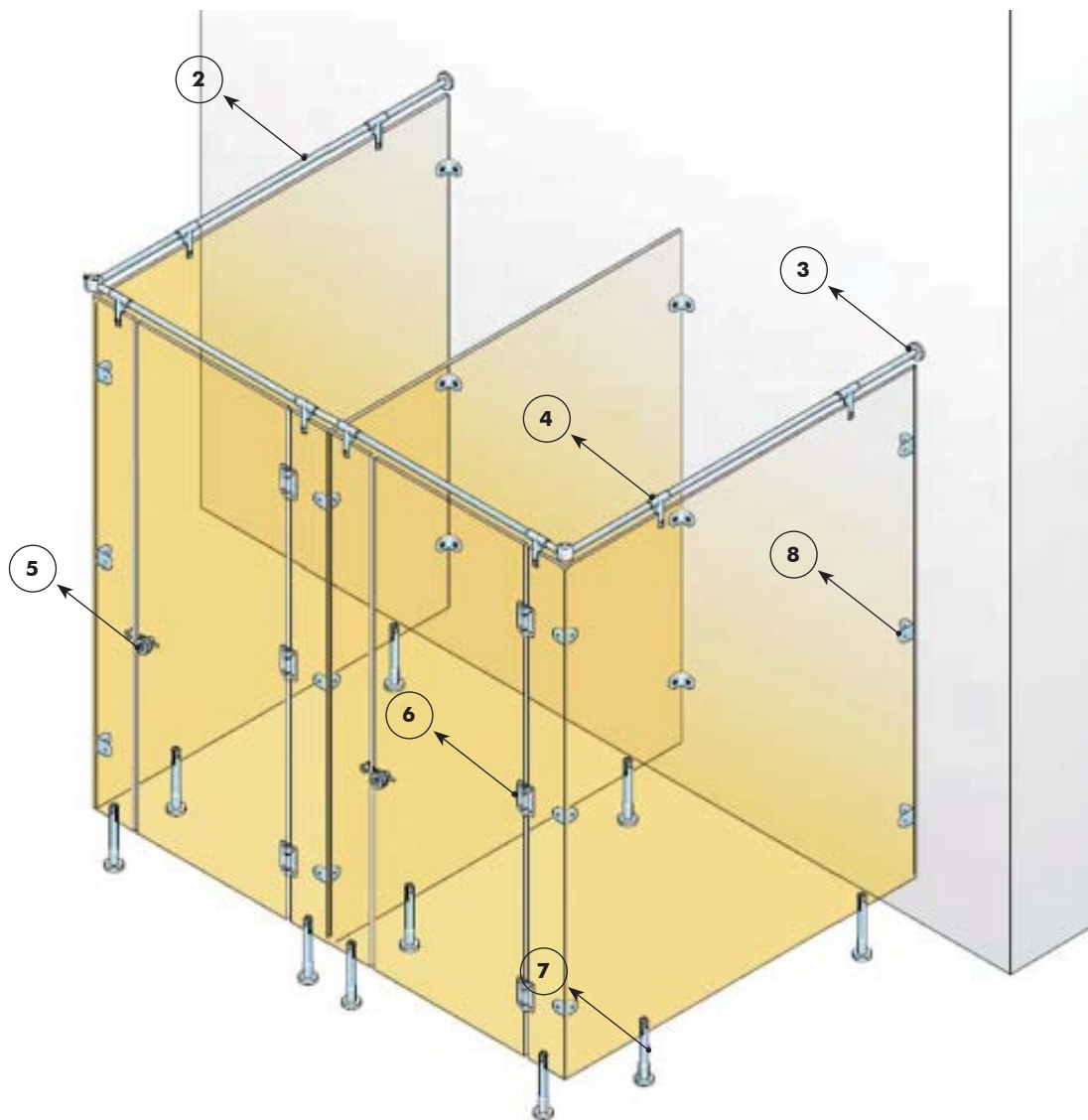

Noga (7)

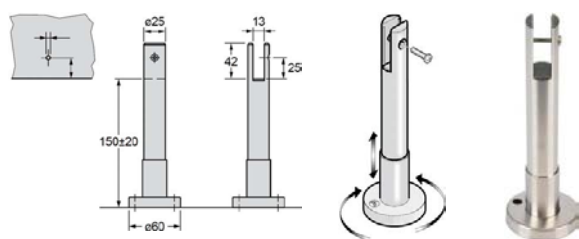

mm	obrada	JM	Šifra art.	Cijena bez PDV-a	Cijena sa PDV-om
150	inox	kom	070933	NA UPIT	

Vežnik cijevi i ploče "T" (4)

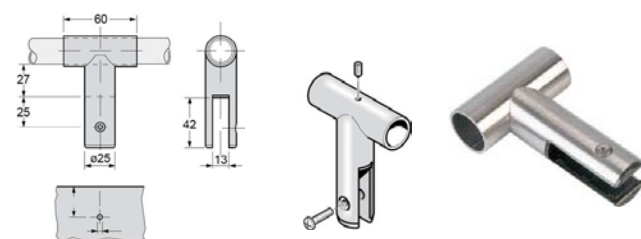

	obrada	JM	Šifra art.	Cijena bez PDV-a	Cijena sa PDV-om
gornji	inox	kom	070934	NA UPIT	

Vežnik cijevi i zida okrugli (3)

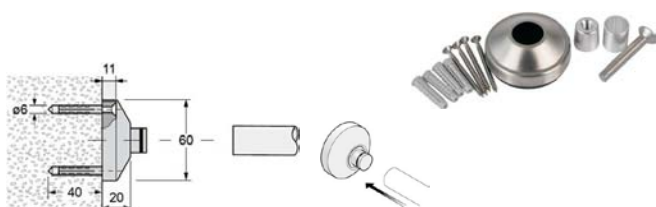

	obrada	JM	Šifra art.	Cijena bez PDV-a	Cijena sa PDV-om
	inox	kom	070936	NA UPIT	

Brava s indikatorom i ručkom (5)

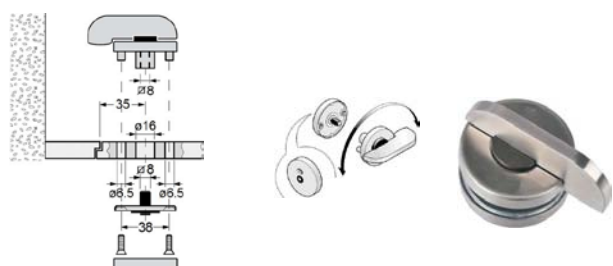

	obrada	JM	Šifra art.	Cijena bez PDV-a	Cijena sa PDV-om
	inox	kom	070940	NA UPIT	

Kutnik (8)

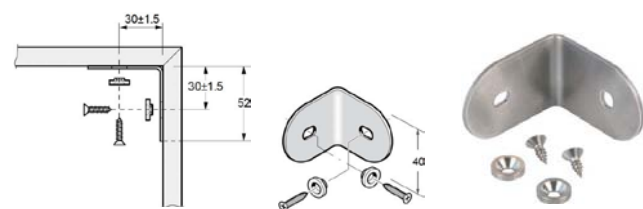

	obrada	JM	Šifra art.	Cijena bez PDV-a	Cijena sa PDV-om
	inox	kom	071121	NA UPIT	

Spojnica (6)

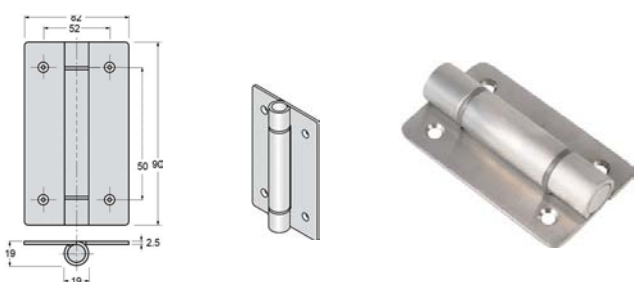

	obrada	JM	Šifra art.	Cijena bez PDV-a	Cijena sa PDV-om
	inox	kom	071123	NA UPIT	

Vežnik cijevi 2l (1)

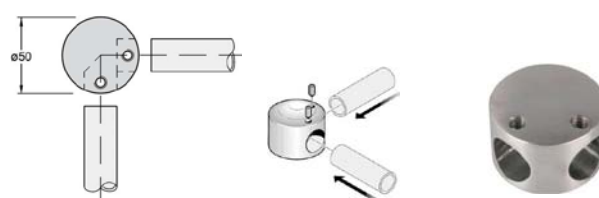

	obrada	JM	Šifra art.	Cijena bez PDV-a	Cijena sa PDV-om
90°	inox	kom	070937	NA UPIT	

Cijev (2)

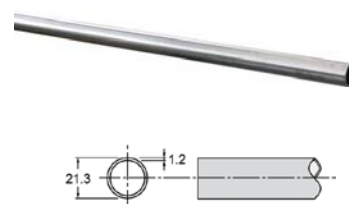

Ø	L	obrada	JM	Šifra art.	Cijena bez PDV-a	Cijena sa PDV-om
21,3x1,6	3m	inox	kom	070941	NA UPIT	

Ručka

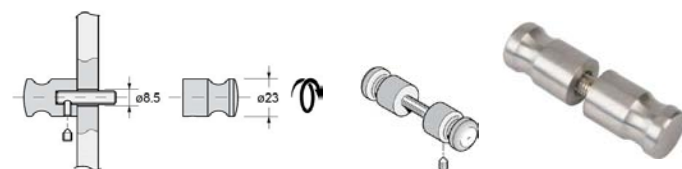

	obrada	JM	Šifra art.	Cijena bez PDV-a	Cijena sa PDV-om
	inox	kom	071122	NA UPIT	

Okov za kompakt ploče

Okov za kompakt ploče

Okovi za kompakt su po narudžbi!!!

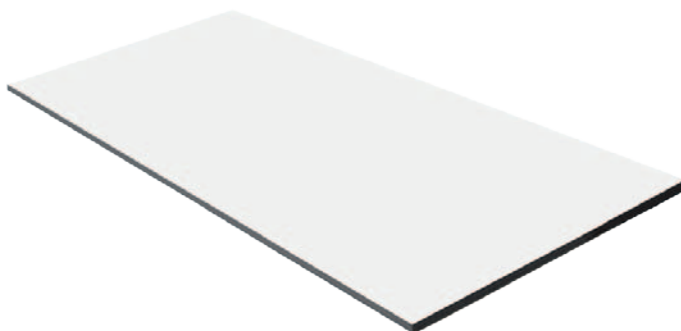

Primjer upotrebe:

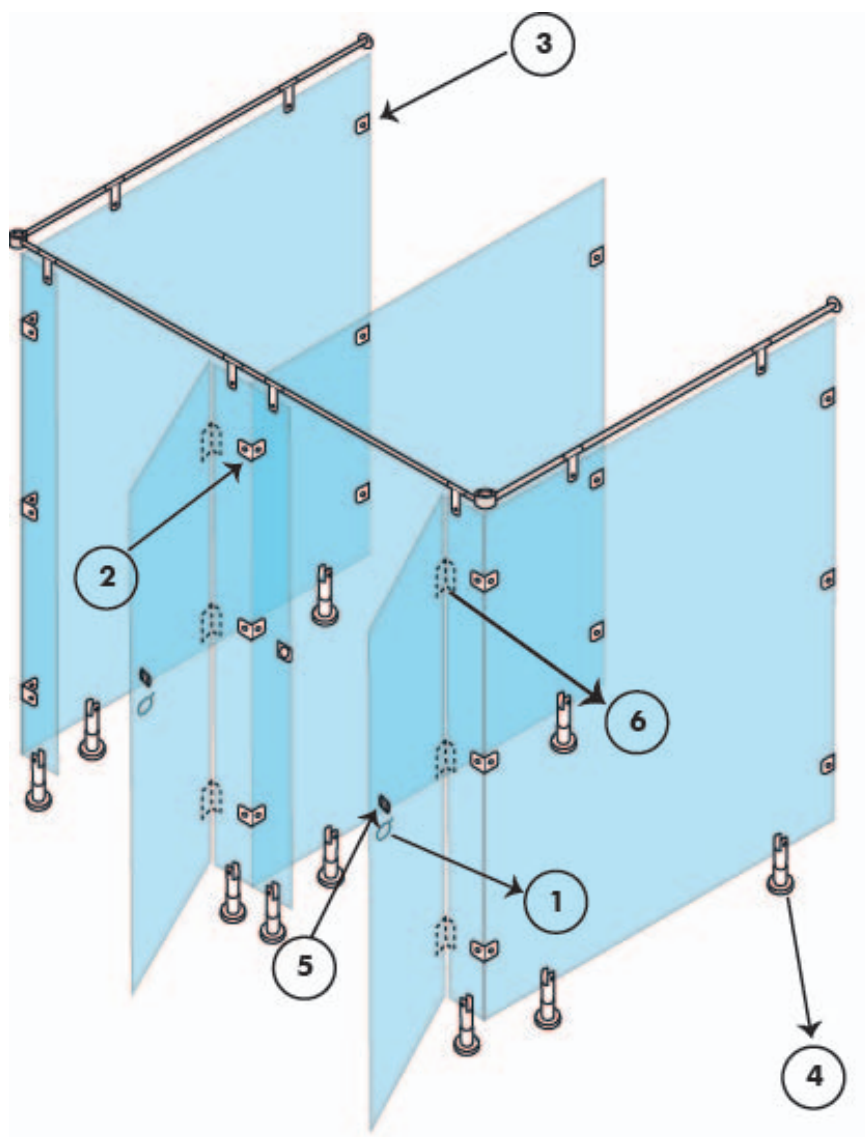

Okov za kompakt ploče

Okov za kompakt ss brava

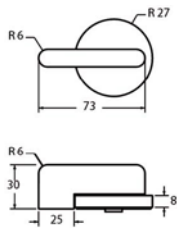

	JM	Šifra art.	Cijena bez PDV-a	Cijena sa PDV-om
	kom	071150	NA UPIT	

Okov za kompakt ss kutnik U

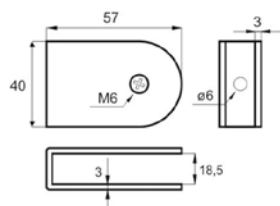

	JM	Šifra art.	Cijena bez PDV-a	Cijena sa PDV-om
	kom	071147	NA UPIT	

Okov za kompakt ss ručka



	JM	Šifra art.	Cijena bez PDV-a	Cijena sa PDV-om
	kom	071149	NA UPIT	

Okov za kompakt ss spojnica polukrug

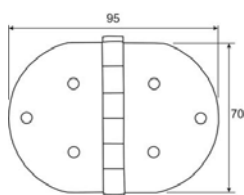

	JM	Šifra art.	Cijena bez PDV-a	Cijena sa PDV-om
	kom	071153	NA UPIT	

Okov za kompakt ss kutnik L



	JM	Šifra art.	Cijena bez PDV-a	Cijena sa PDV-om
	kom	071148	NA UPIT	

Okov za kompakt ss noga

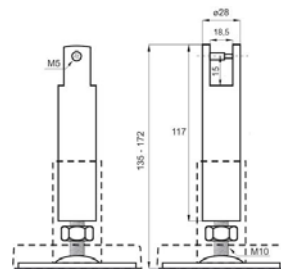

	JM	Šifra art.	Cijena bez PDV-a	Cijena sa PDV-om
135-172mm	kom	071151	NA UPIT	

Okov za kompakt ss spojnica

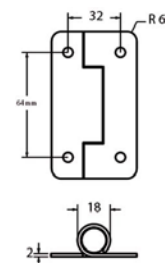

	JM	Šifra art.	Cijena bez PDV-a	Cijena sa PDV-om
	kom	071152	NA UPIT	

Okov za kompakt ploče

Okovi za kompakt su po narudžbi!!!

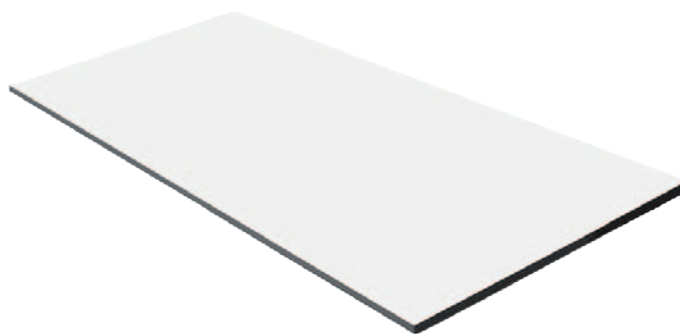

Primjer upotrebe:

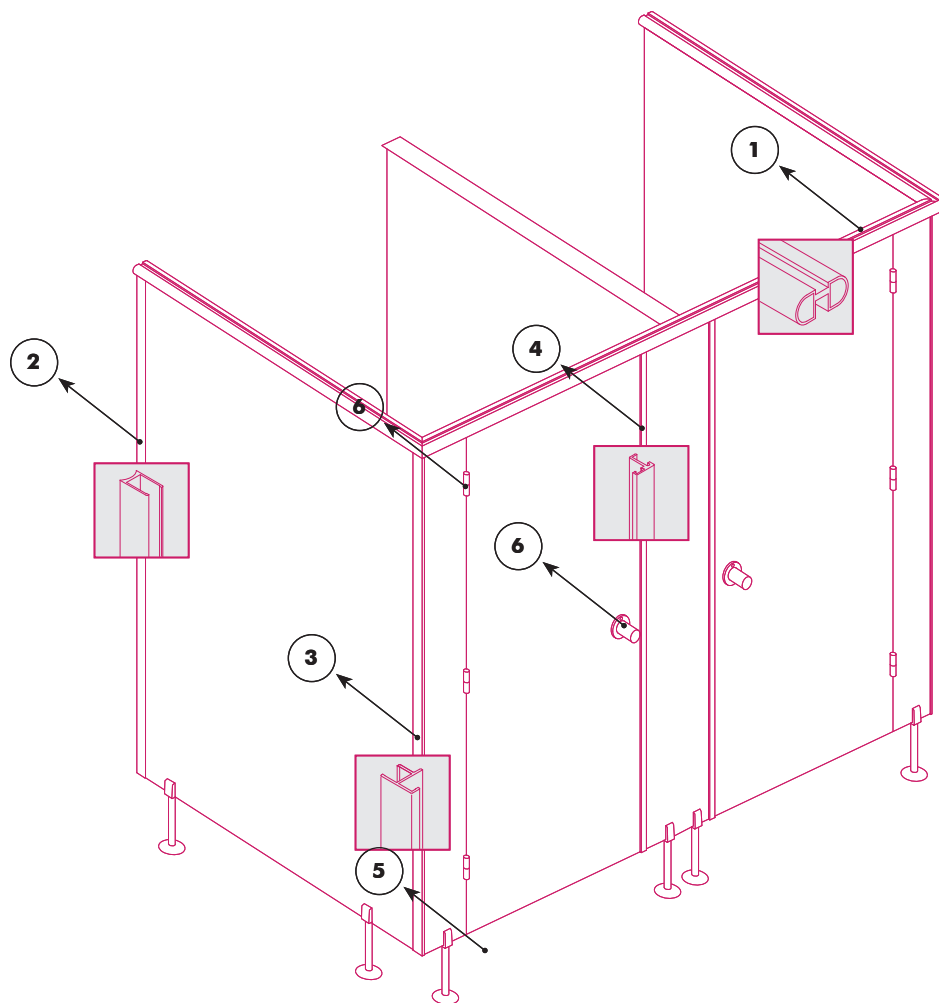

Kompakt okov gornji profil (1)



	JM	Šifra art.	Cijena bez PDV-a	Cijena sa PDV-om
6m, alu	kom	190537	NA UPIT	

Kompakt okov zidni profil (2)



	JM	Šifra art.	Cijena bez PDV-a	Cijena sa PDV-om
6m, alu	kom	190538	NA UPIT	

Kompakt okov kutni profil (3)

	JM	Šifra art.	Cijena bez PDV-a	Cijena sa PDV-om
6m, alu	kom	190539	NA UPIT	

Kompakt okov nogica (5)

	JM	Šifra art.	Cijena bez PDV-a	Cijena sa PDV-om
alu	kom	190541	NA UPIT	

Kompakt okov spojnica (6)

alu



	JM	Šifra art.	Cijena bez PDV-a	Cijena sa PDV-om
lijeva	kom	190543	NA UPIT	
desna	kom	190544	NA UPIT	

Kompakt okov brava (7)

	JM	Šifra art.	Cijena bez PDV-a	Cijena sa PDV-om
mat inox	kom	190548	NA UPIT	

Kompakt okov vrata stop profil (4)

	JM	Šifra art.	Cijena bez PDV-a	Cijena sa PDV-om
6m, alu	kom	190540	NA UPIT	

Kompakt okov brtva soft 10m

	JM	Šifra art.	Cijena bez PDV-a	Cijena sa PDV-om
10m	kom	190542	NA UPIT	

Kompakt okov samozatvarajuća spojnica (6)

alu

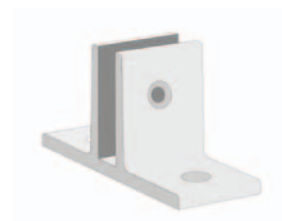

	JM	Šifra art.	Cijena bez PDV-a	Cijena sa PDV-om
lijeva	kom	190545	NA UPIT	
desna	kom	190546	NA UPIT	

Kompakt okov nosač sanit. pregrade

	JM	Šifra art.	Cijena bez PDV-a	Cijena sa PDV-om
alu	kom	190547	NA UPIT	

