



19/03/24



Max&Moris

Noge za namještaj,
kotačići i uredska oprema



”

There is no magic in magic,
it's all in the details.

Walt Disney

Koncept

Noge za namještaj

Nogice

Podšavajuće nogice i vijci za regulaciju

Kotačići

Uredska oprema

*MAX & MORIS d.o.o. zadržava pravo izmjene tehničkih podataka i cijena bez prethodne najave.
Cijene su iskazane sa uključenim PDV-om od 25%.

Prema odluci Vijeća Europske unije, fiksni tečaj konverzije prema kojem se vrši preračunavanje cijena je:
1 euro = 7,53450 kuna.

Slike u katalogu su informativnog karaktera te ne garantiramo potpunu podudarnost slika i stvarnog izgleda.
Za tiskarske greške ne odgovaramo.



Noga za kuhinjski otok Italice

[DO ISTEKA ZALIHA](#)

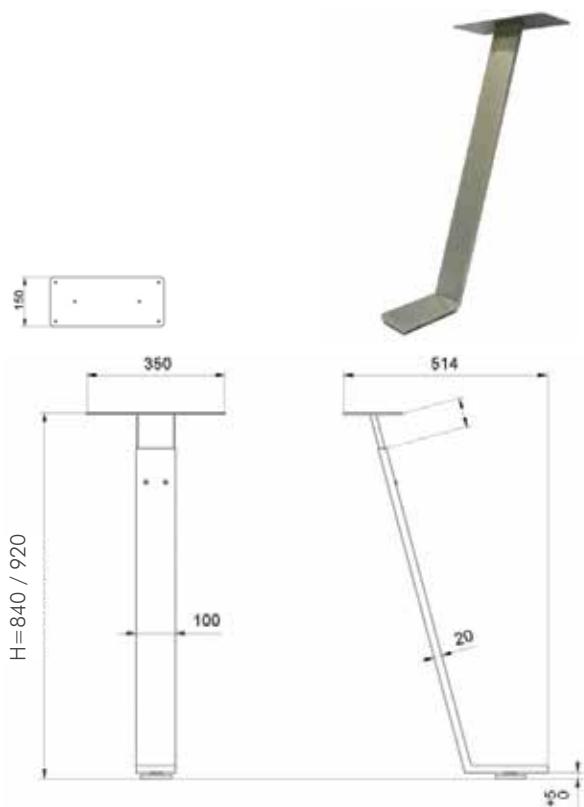

H	Obrada	JM	Šifra art.	Cijena sa PDV-om	
820	RAL 9006	kom	180125	150 ^{13€}	1.131 ^{16kn}



Noga za kuhinjski otok Danese

[DO ISTEKA ZALIHA](#)

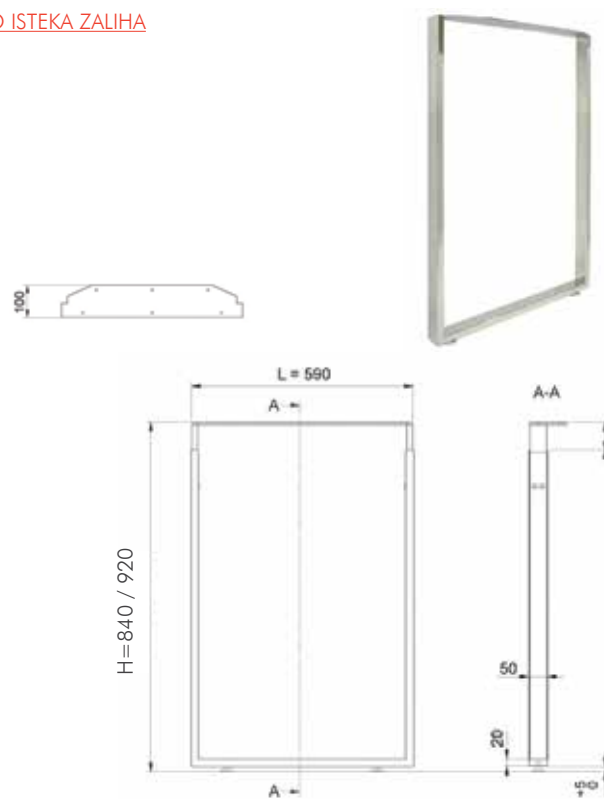

H	Obrada	JM	Šifra art.	Cijena sa PDV-om	
820	krom sjaj	kom	180123	209 ^{86€}	1.581 ^{17kn}
820	RAL 9006	kom	180124	128 ^{74€}	969 ^{97kn}
820	antracit mat	kom	180234	180 ^{43€}	1.359 ^{48kn}



Noga za stol okrugla Wood FE

NARUŽBA

Obrada: drvo / metal

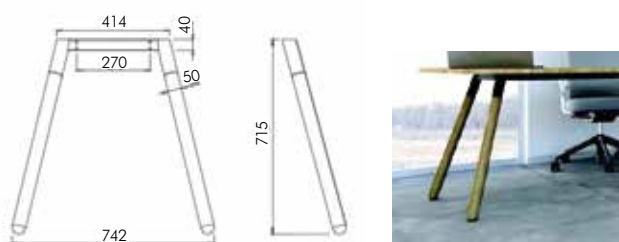

Dim	V mm	Š mm	JM	Šifra art.	Cijena sa PDV-om	
Ø 50 / 800	715	742	kom	009631495	147 ⁶⁶ €	1.112 ⁵⁷ kn

Noga za stol pravokutna Wood FE

NARUŽBA

Obrada: drvo/metal

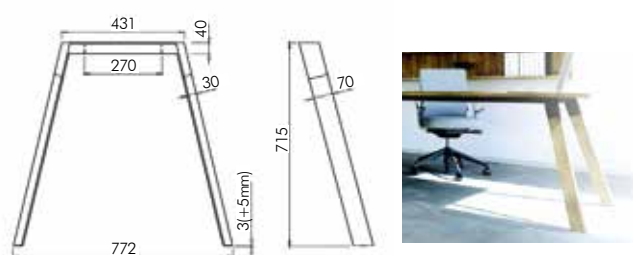

Dim	V mm	Š mm	JM	Šifra art.	Cijena sa PDV-om	
70x30 / 800	715	772	kom	009631494	149 ⁰⁸ €	1.123 ²³ kn

Uzdužni profil za stol Hide

NARUŽBA

Za noge Wood FE i HUBO

Napomena: za izradu jednog stola potrebne su dvije noge i dva profila

Profili dolaze u alu boji, ali se mogu plastificirati i u drugu boju

[Dužina profila = dužina ploče stola - 400mm](#)

WOOD



HUBO

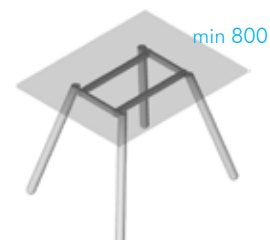

Dim. mm	Obrada	JM	Šifra art.	Cijena sa PDV-om	
800	alu 9006	kom	009631421	15 ⁹² €	119 ⁹² kn
1200	alu 9006	kom	009631423	21 ⁹² €	165 ¹⁷ kn
1400	alu 9006	kom	009631424	24 ⁹³ €	187 ⁸² kn
1600	alu 9006	kom	009631425	29 ¹⁵ €	219 ⁶⁵ kn
1800	alu 9006	kom	009631426	29 ⁴⁴ €	221 ⁷⁹ kn
2000	alu 9006	kom	009631427	35 ³⁸ €	266 ⁵⁸ kn



Noge za namještaj

Noga A-Leg

NARUDŽBA

Noge A-Leg su samostalne i za njih nisu potrebni profili
 Ploča stola min debljine 25mm

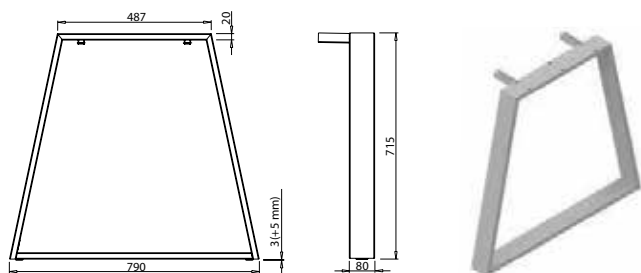

VxŠ mm	Obrada	JM	Šifra art.	Cijena sa PDV-om	
715x790	antracit	kom	009630654-7016	116 ⁵¹ €	877 ⁸² kn
715x790	crna	kom	009620654 lager	9947€	749 ⁴² kn
715x790	RAL 9006G	kom	009630654 lager	987 ⁰ €	743 ⁶⁵ kn



Noga U-Leg

NARUDŽBA

Noge U-Leg su samostalne i za njih nisu potrebni profili
 Ploča stola min debljine 25mm

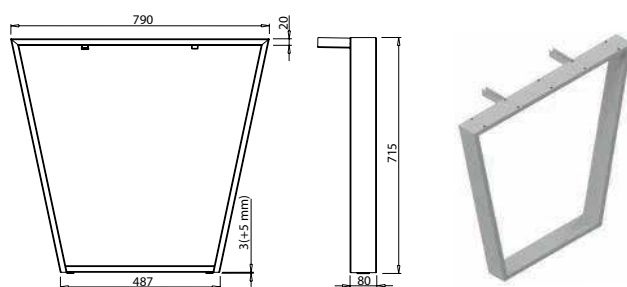

VxŠ mm	Obrada	JM	Šifra art.	Cijena sa PDV-om	
715x790	antracit	kom	009630655-7016	116 ⁵¹ €	877 ⁸² kn
715x790	crna	kom	009620655 lager	987 ⁰ €	743 ⁶⁵ kn
715x790	RAL 9006G	kom	009630655	987 ⁰ €	743 ⁶⁵ kn



Noga O-Leg

NARUDŽBA

Noge O-Leg su samostalne i za njih nisu potrebni profili
 Ploča stola min debljine 25mm

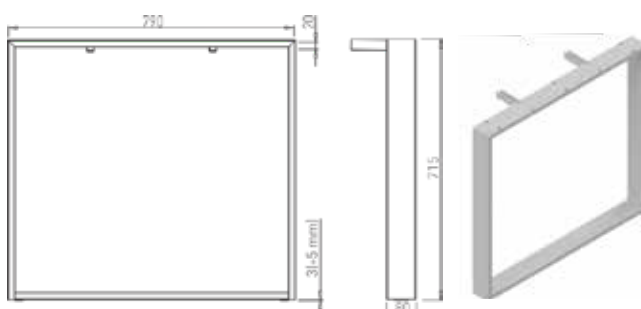

VxŠ mm	Obrada	JM	Šifra art.	Cijena sa PDV-om	
715x790	antracit	kom	009630656-7016	124 ⁸² €	940 ⁴⁹ kn
715x790	crna	kom	009620656 lager	987 ⁰ €	743 ⁶⁵ kn
715x790	RAL 9006G	kom	009630656	108 ³⁸ €	816 ⁵⁷ kn



Noge za namještaj

Noga za stol SR45



1) montaža plohe stola vijcima $\varnothing 5$ mm,
6 rupa $\varnothing 5$ mm na svakoj nozi stola

PAZI JM je kom

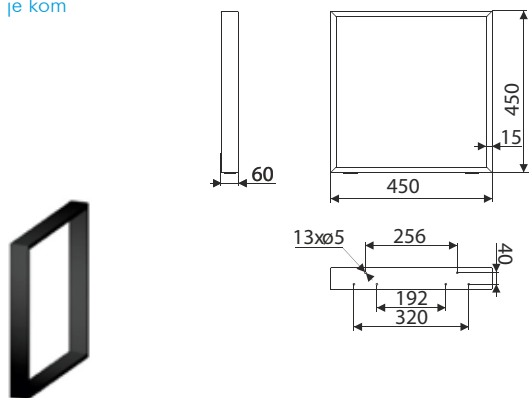

visina mm	materijal	obrada	JM	Šifra art.	Cijena sa PDV-om	
450	čelik	crna	kom	671106	58 ⁰¹ €	437 ⁰⁷ kn

Noga za stol SR23



1) montaža plohe stola vijcima $\varnothing 5$ mm, 13 rupa $\varnothing 5$ mm na svakoj nozi stola

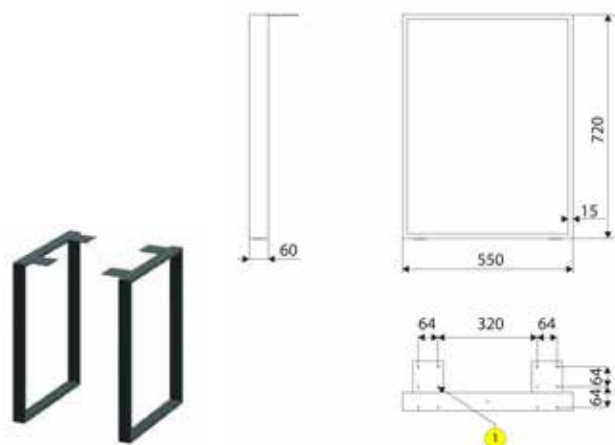

visina mm	materijal	obrada	JM	Šifra art.	Cijena sa PDV-om	
720	čelik	crna	par	671008	182 ⁹⁷ €	1.378 ⁵⁵ kn

Noga za stol SR24



1) montaža plohe stola vijcima $\varnothing 5$ mm, 13 rupa $\varnothing 5$ mm na svakoj nozi stola



visina mm	materijal	obrada	JM	Šifra art.	Cijena sa PDV-om	
720	čelik	crna	par	671009	185 ²⁶ €	1.395 ⁸⁵ kn

Noge za namještaj

Noga za stol X

GAMET.

materijal: čelik

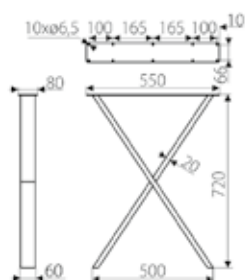
 montaža plohe stola vijcima $\varnothing 5$ mm, 10 rupa $\varnothing 5$ mm na svakoj nozi stola

VxŠ mm	obrada	JM	Šifra art.	Cijena sa PDV-om	
720x550	crna	par	671016	10464€	78840kn



GV noga stola industria P

GTV.

materijal: čelik

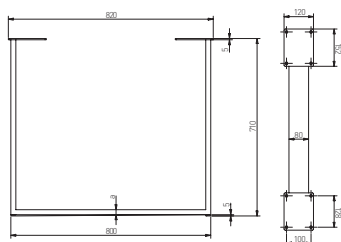

dim mm	a mm	Obrada	JM	Šifra art.	Cijena sa PDV-om	
710x820	20	crna	kom	090424	13567€	1.02221kn
710x820	40	crna	kom	090425	14839€	1.11804kn
710x820	80	crna	kom	090426	17383€	1.30972kn



GV noga stola industria X

GTV.

materijal: čelik

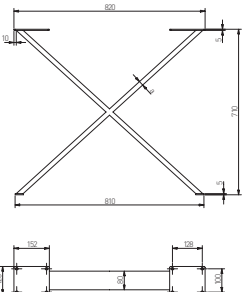

dim mm	a mm	Obrada	JM	Šifra art.	Cijena sa PDV-om	
710x820	40	crna	kom	090429	15687€	1.18194kn
710x820	80	crna	kom	090430	19079€	1.43751kn



GV noga stola industria T

GTV.

materijal: čelik

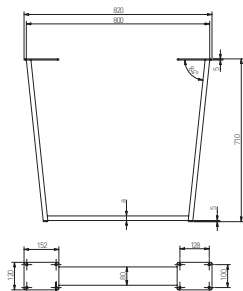

dim mm	a mm	Obrada	JM	Šifra art.	Cijena sa PDV-om	
710x820	20	crna	kom	090427	13567€	1.02221kn
710x820	40	crna	kom	090428	13991€	1.05415kn



Noge za namještaj

Profil sistem noga SR66

materijal: čelik

GAMET

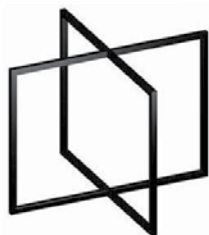

visina mm	obrada	JM	Šifra art.	Cijena sa PDV-om	
440	crna	kom	671107	57 ⁸⁸ €	436 ¹⁰ kn

GV noga stola Arto DO ISTEKA ZALIHA

materijal: metal

obrada: crna

GTV

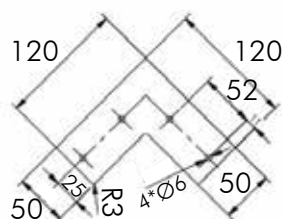
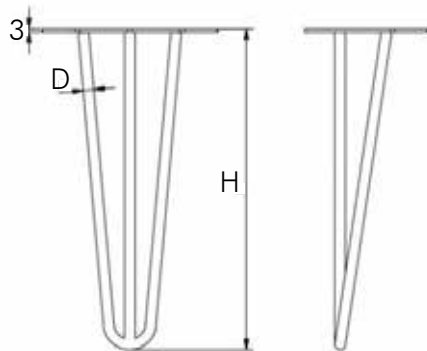
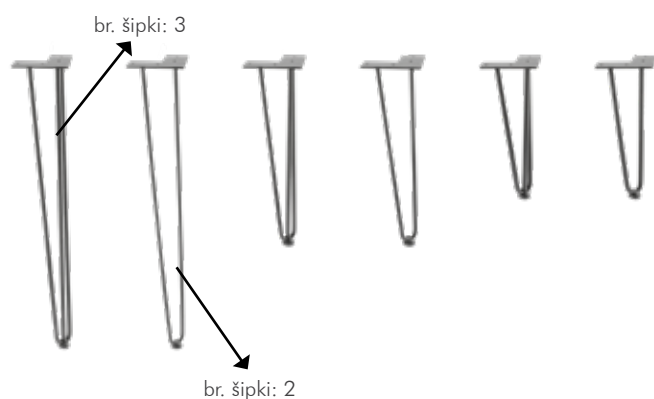

D mm	H mm	br. šipki	JM	Šifra art.	Cijena sa PDV-om	
Ø10	304	2	kom	090418	114 ³ €	86 ¹⁰ kn
Ø10	406	2	kom	090419	117 ¹ €	88 ²⁰ kn
Ø10	711	2	kom	090420	130 ⁵ €	98 ³⁰ kn
Ø10	304	3	kom	090421	104 ⁴ €	78 ⁶³ kn
Ø10	406	3	kom	090422	121 ⁴ €	91 ⁵⁰ kn
Ø10	711	3	kom	090423	152 ⁰ €	114 ⁵⁰ kn

Noga za namještaj

Noga Riex GS43

Čelična noga za namještaj - zavarena od čelične žice i punog lima. Mat crna boja. podešavanje visine +2mm 3mm debljina pločice

franipex

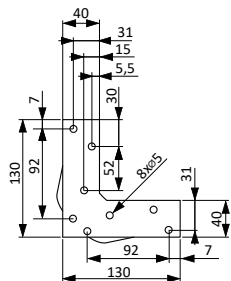
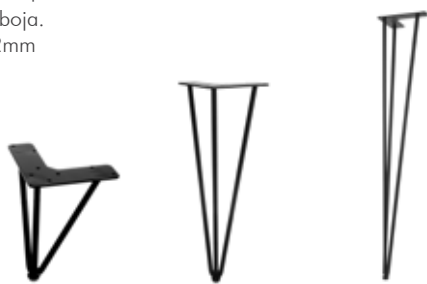

H mm	Ø šipke mm	obrada	JM	Šifra art.	Cijena sa PDV-om	
130	10	crna	kom	780012	430€	32 ⁴⁰ kn
400	10	crna	kom	780013	736€	55 ⁴⁵ kn
710	10	crna	kom	780014	1312€	98 ⁸⁵ kn

Noga

Materijal: željezo

[DO ISTEKA ZALIHA](#)



emuca

- aluminiј
- krom
- rosftr.
- bijela
- crna

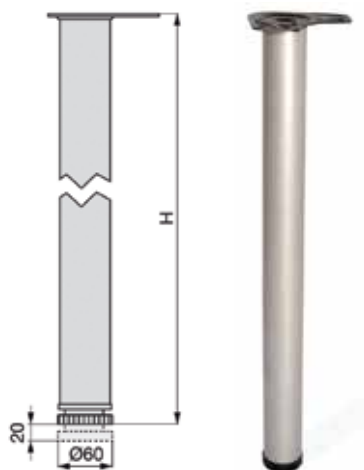

H mm	Ø mm	Obrada	JM	Šifra art.	Cijena sa PDV-om	
710	60	aluminiј	kom	820124	22 ⁶⁴ €	170 ⁶⁰ kn
830	60	aluminiј	kom	820127	23 ⁸⁵ €	179 ⁶⁸ kn
710	60	krom	kom	820121	23 ²⁰ €	174 ⁷⁸ kn
830	60	krom	kom	820126	23 ⁸⁵ €	179 ⁶⁸ kn
710	60	rosftr.	kom	820125	26 ⁷⁷ €	201 ⁶⁹ kn
830	60	rosftr.	kom	820128	23 ⁸⁵ €	179 ⁶⁸ kn
710	60	bijela	kom	820122	22 ⁶⁴ €	170 ⁶⁰ kn
710	60	crna	kom	820123	22 ⁶⁴ €	170 ⁶⁰ kn

Noga Riex GS42

Čelična noga za namještaj - zavarena od čelične žice i punog lima. Mat crna boja. nema podešavanja visine 3mm debljina pločice

franipex

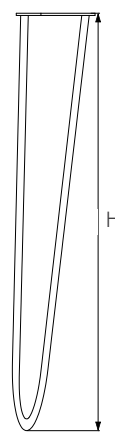
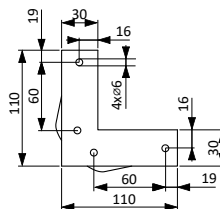

H mm	Ø šipke mm	obrada	JM	Šifra art.	Cijena sa PDV-om	
130	10	crna	kom	780015	412€	310 ⁴ kn
400	10	crna	kom	780016	542€	408 ⁴ kn
710	10	crna	kom	780017	1100€	82 ⁸⁸ kn

Noga

Materijal: ZnAl, željezo

GTV

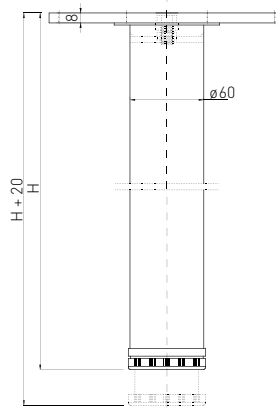
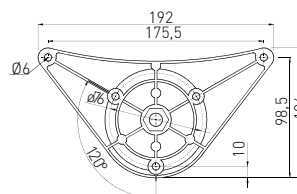

- aluminiј
- bijela

H mm	Ø mm	Obrada	JM	Šifra art.	Cijena sa PDV-om	
710	60	bijela	kom	090401	1217€	91 ⁶⁹ kn
820	60	alu	kom	090450	1777€	133 ⁹⁰ kn



GV Zglobna noga NM-X-LINE

materijal: čelik, plastika

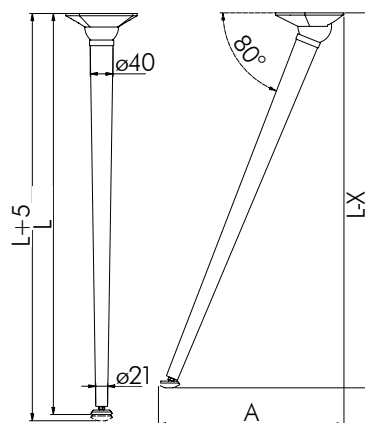

H	Obrada	JM	Šifra art.	Cijena sa PDV-om	
710 + 5mm	crna	kom	090412	1918€	14448kn
710 + 5mm	bijela	kom	090413	1918€	14448kn

Noge za namještaj

Noga za stol Solo simple

NARUDŽBA

Noga se može plastificirati u crnu i antracit boju.

Za izradu jednog stola potrebne su dvije noge Solo simple i jedan [veznik Connector Solo](#).

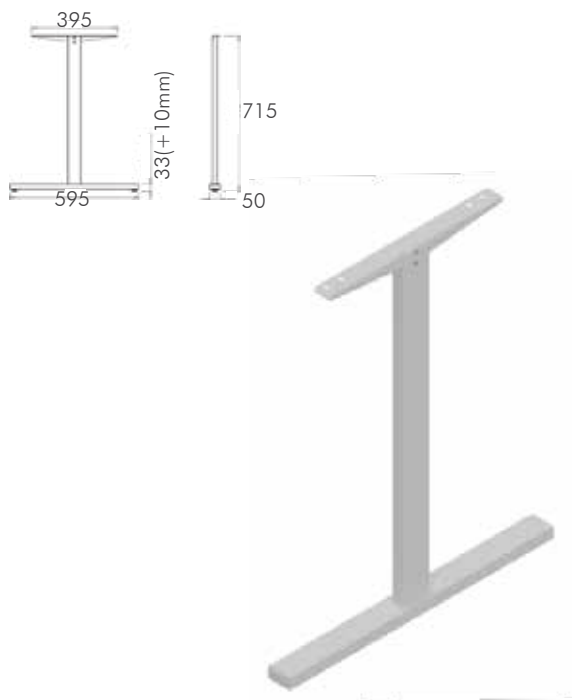

VxŠ mm	Obrada	JM	Šifra art.	Cijena sa PDV-om	
715x595	alu 9006G	kom	009630792	51 ⁸⁴ €	390 ⁶¹ kn

Veznik Connector solo

NARUDŽBA

Za nogu Solo simple

Napomena: za izradu jednog stola potrebne su dvije noge Solo simple i jedan veznik

Connector solo

[Duljina veznika treba biti 40cm manja od duljine ploče stola](#)



Duž. mm	Obrada	JM	Šifra art.	Cijena sa PDV-om	
800	alu 9006G	kom	009630818	14 ⁴⁶ €	108 ⁹⁷ kn
1000	alu 9006G	kom	009630819	17 ¹⁹ €	129 ⁵² kn
1200	alu 9006G	kom	009630816	19 ⁹² €	150 ⁰⁷ kn
1400	alu 9006G	kom	009630814	22 ⁶⁵ €	170 ⁶⁵ kn
1600	alu 9006G	kom	009630815	26 ⁴⁹ €	199 ⁵⁹ kn
1800	alu 9006G	kom	009630974	29 ⁴² €	221 ⁶⁸ kn
2000	alu 9006G	kom	009630126	32 ¹⁵ €	242 ²² kn

Star noga T 600

DO ISTEKA ZALIHA

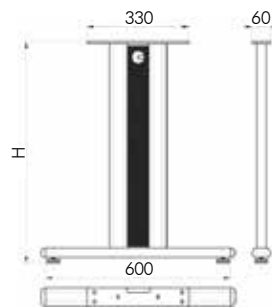

crna

H	obrada	JM	Šifra art.	Cijena sa PDV-om	
715	crna	kom	070804	56 ⁸¹ €	428 ⁰³ kn

Star veznik

DO ISTEKA ZALIHA

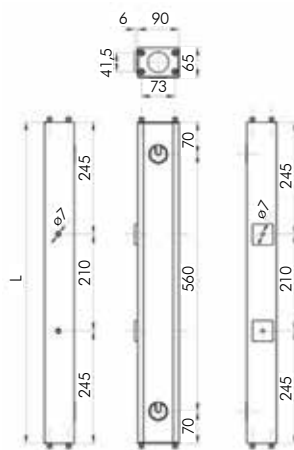

mm	opis	JM	Šifra art.	Cijena sa PDV-om	
900		kom	070806	29 ⁵¹ €	222 ³⁴ kn
1300		kom	070807	46 ⁷⁵ €	352 ²⁴ kn
1500		kom	070808	52 ⁵⁸ €	396 ¹⁶ kn
1700		kom	070809	55 ⁰⁷ €	414 ⁹² kn

Noge za namještaj

Star nosač uredske noge

[DO ISTEKA ZALIHA](#)

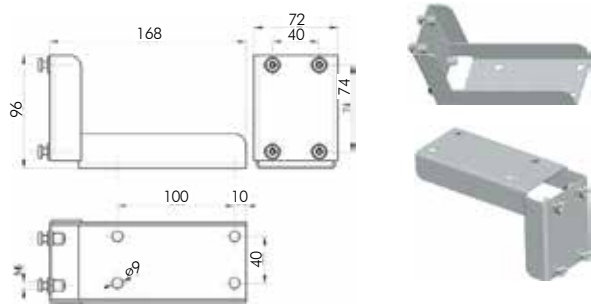

	opis	JM	Šifra art.	Cijena sa PDV-om	
	siva	kom	070874	221 ⁸ €	167 ¹² kn

Cubo podešivač visine za noge Hubo

NARUDŽBA

Za jednu nogu potrebna su dva kompleta Cubo podešivača. Pomoću podešivača visina stola može se prilagoditi od 736 do 856 mm.

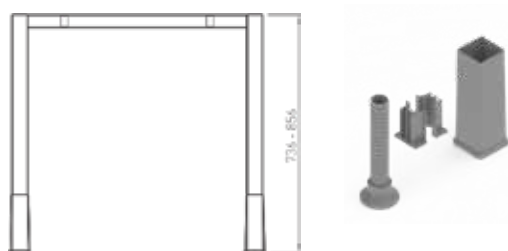

materijal	obrada	JM	Šifra art.	Cijena sa PDV-om	
PVC	siva	kom	009630709	91 ⁰ €	68 ⁵⁶ kn

Noga za stol Hubo 50/600

NARUDŽBA

Uz noge koristiti [uzdužni profil HIDE](#) koji se nalazi kod nogu WOOD. Za izradu jednog stola potrebne su dvije noge i dva profila

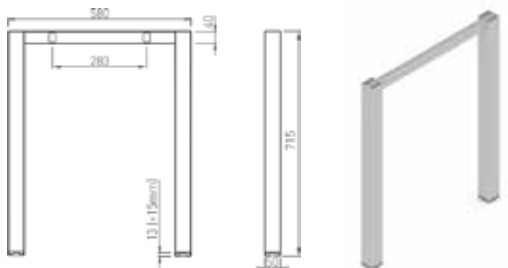

V*Š mm	obrada	JM	Šifra art.	Cijena sa PDV-om	
715x580	siva	kom	009631419	871 ³ €	656 ⁴⁷ kn

Nosač kompjutera

hvatanje na gornju ploču (2 kom)

[DO ISTEKA ZALIHA](#)

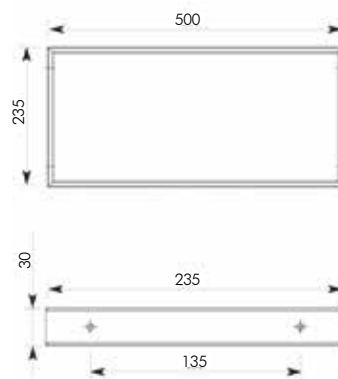

gar	opis	JM	Šifra art.	Cijena sa PDV-om	
2kom		par	070873	58 ³⁸ €	439 ⁸⁶ kn

Noga za stol Hubo 50/800

NARUDŽBA

Uz noge koristiti [uzdužni profil HIDE](#) koji se nalazi kod nogu WOOD. Za izradu jednog stola potrebne su dvije noge i dva profila

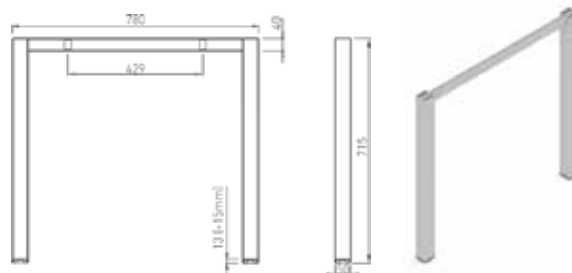

V*Š mm	obrada	JM	Šifra art.	Cijena sa PDV-om	
715x780	siva	kom	009631420	88 ⁴⁶ €	666 ⁵⁰ kn



Noge za namještaj

Noga Riex GR72

Materijal: PVC

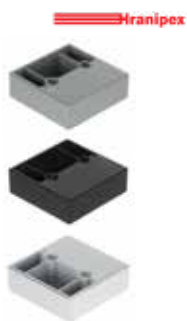
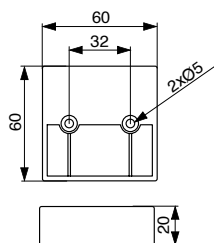

H mm	dim. mm	Obrada	JM	Šifra art.	Cijena sa PDV-om	
20	60x60	srebro	kom	780052	167€	1258kn
20	60x60	crna	kom	780053	173€	1303kn
20	60x60x	krom	kom	780054	202€	1522kn

Noga PVC

emuca

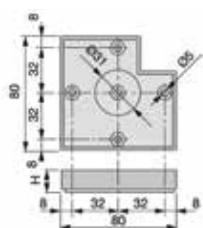

H mm	Obrada	JM	Šifra art.	Cijena sa PDV-om	
15	siva	kom	820031	176€	1324kn
30	siva	kom	820028	193€	1451kn
45	siva	kom	820032	242€	1824kn

Nogica NS61

GAMET



H mm	Obrada	JM	Šifra art.	Cijena sa PDV-om	
54	krom	kom	670030	579€	4359kn

Nogica Merit

materijal: PVC



H mm	Obrada	JM	Šifra art.	Cijena sa PDV-om	
58	mat krom	kom	740047	140€	1055kn
58	crna	kom	740050	124€	932kn

Noga Riex GR73

Materijal: PVC

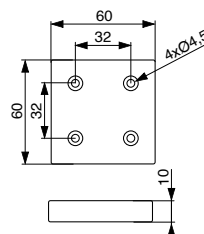

H mm	dim. mm	Obrada	JM	Šifra art.	Cijena sa PDV-om	
10	60x60	srebro	kom	780055	141€	1062kn
10	60x60	krom	kom	780056	221€	1665kn
10	60x60x	crna	kom	780057	142€	1070kn

Noga PVC

emuca

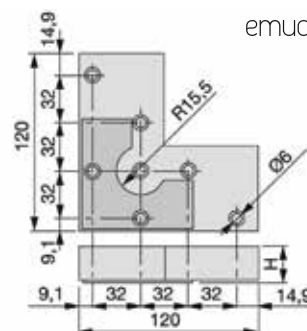

H mm	Obrada	JM	Šifra art.	Cijena sa PDV-om	
12	siva	kom	820033	216€	1629kn
24	siva	kom	820030	245€	1849kn

Nogica Vase

materijal: PVC



H mm	Obrada	JM	Šifra art.	Cijena sa PDV-om	
50	bijela	kom	740051	124€	938kn
50	crna	kom	740052	124€	938kn

Noga klizač

Opterećenje cca 25kg

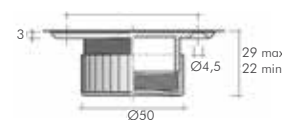
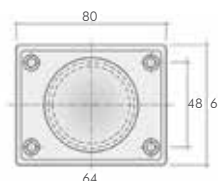

H mm	Obrada	JM	Šifra art.	Cijena sa PDV-om	
22-29	crna	kom	501453	221€	1665kn
22-29	srebrna	kom	501454	221€	1665kn

Noge za namještaj

Noga X

Aluminij

[DO ISTEKA ZALIHA](#)



H	mm	Obrada	JM	Šifra art.	Cijena sa PDV-om	
50	40x40	alu	kom	070905	454€	3422kn
100	40x40	alu	kom	070906	586€	4413kn
100	60x60	alu	kom	070909	638€	4807kn

Noga

Materijal: aluminij

[DO ISTEKA ZALIHA](#)

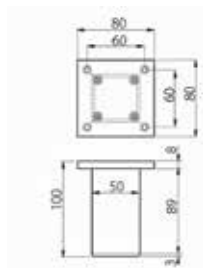

H	Obrada	JM	Šifra art.	Cijena sa PDV-om	
100	aluminij	kom	090166	750€	5653kn

Nogica Eco metalna

materijal: metal

[DO ISTEKA ZALIHA](#)



H	mm	Obrada	JM	Šifra art.	Cijena sa PDV-om	
100	25x25	mat krom	kom	740057	282€	2121kn
150	25x25	mat krom	kom	740059	422€	3181kn

Noge za namještaj, kotačići i uredska oprema

Noga

Materijal: aluminij

[DO ISTEKA ZALIHA](#)

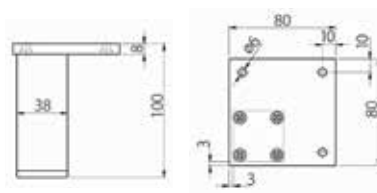

H	Obrada	JM	Šifra art.	Cijena sa PDV-om	
100	aluminij	kom	090167	726€	5470kn

Noga Alumix [DO ISTEKA ZALIHA](#)

PVC

emuca



H	Obrada	JM	Šifra art.	Cijena sa PDV-om	
100	siva	kom	820027	251€	1893kn

Noga Riex GA35

Mranipex

Materijal: aluminij / plastika

Montaža na dno ormarića s 4 vijka. Noga ima podešavanje visine od 15 mm.

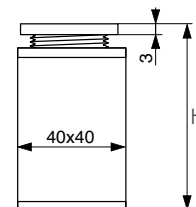
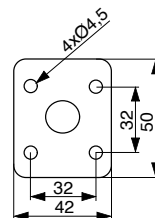

H	dim. mm	Obrada	JM	Šifra art.	Cijena sa PDV-om	
60	40x40	alu	kom	780033	173€	1303kn
100	40x40	alu	kom	780034	245€	1846kn
150	40x40	alu	kom	780035	333€	2509kn
60	40x40	mat crna	kom	780036	272€	2049kn
100	40x40	mat crna	kom	780037	354€	2667kn
150	40x40	mat crna	kom	780042	481€	3624kn

Noge za namještaj

Noga Riex GA36

Materijal: aluminij / plastika

Montaža na dno ormarića s 4 vijka. Noga ima podešavanje visine od 15 mm.

 Hranipex

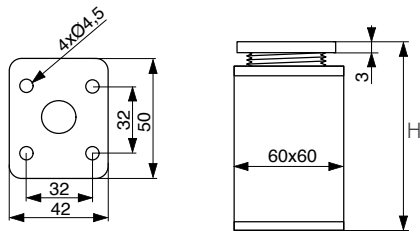

H mm	dim. mm	Obrada	JM	Šifra art.	Cijena sa PDV-om	
60	60x60	alu	kom	780038	371€	27 ⁹⁵ kn
100	60x60	alu	kom	780039	498€	37 ⁵² kn
150	60x60	alu	kom	780043	642€	48 ³⁷ kn
60	60x60	mat crna	kom	780040	373€	28 ¹⁰ kn
100	60x60	mat crna	kom	780041	588€	44 ³⁰ kn

Noga s regulacijom

Materijal: aluminij

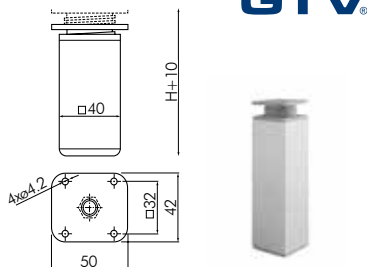

H	Obrada	JM	Šifra art.	Cijena sa PDV-om	
60	aluminij	kom	090390	179€	134 ⁹ kn
100	aluminij	kom	090391	245€	184 ⁶ kn
150	aluminij	kom	090392	315€	237 ³ kn

Noga s regulacijom

Materijal: čelik

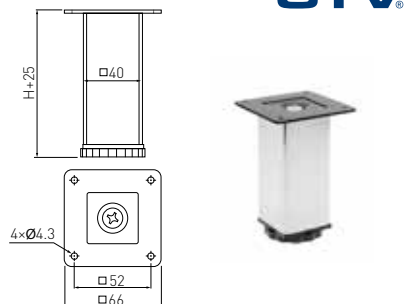

H	Obrada	JM	Šifra art.	Cijena sa PDV-om	
100	sivo/crno	kom	090389	318€	239 ⁹ kn

Noga PN57

PVC

regulacija +/- 25mm

 GAMET.

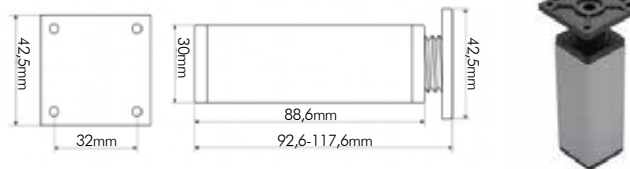

H mm	Obrada	JM	Šifra art.	Cijena sa PDV-om	
70	crna	kom	670146	214€	161 ² kn
118	crna	kom	670147	222€	167 ⁰ kn
142	crna	kom	670149	227€	170 ⁹ kn

Noga

Materijal: čelik

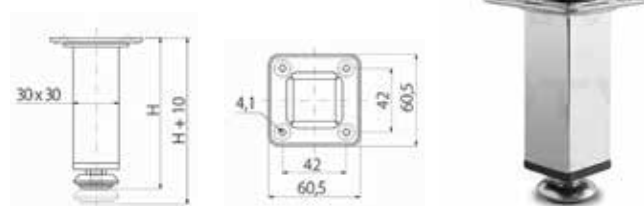

H	Obrada	JM	Šifra art.	Cijena sa PDV-om	
150	krom	kom	090161	457€	344 ⁴ kn

Noga Riex GS26

Materijal: čelik

Noga ima podešavanje visine od 7 mm.

 Hranipex

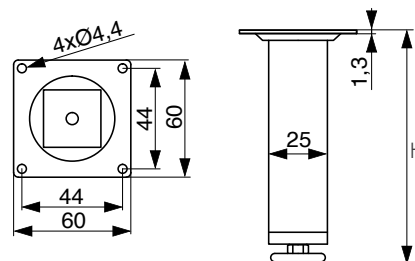

H mm	dim. mm	Obrada	JM	Šifra art.	Cijena sa PDV-om	
100	25x25	mat krom	kom	780003	201€	151 ⁴ kn
150	25x25	mat krom	kom	780004	245€	184 ⁶ kn
100	25x25	mat crna	kom	780048	156€	117 ⁵ kn
150	25x25	mat crna	kom	780049	205€	154 ⁵ kn

Noge za namještaj

Noga Riex GA34

Materijal: aluminij / plastika

Montaža na dno ormarića s 4 vijka. Noga ima podešavanje visine od 15 mm.

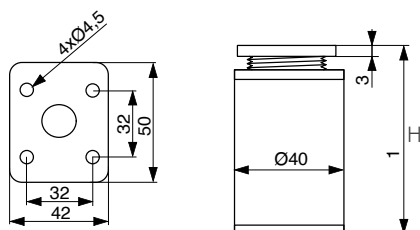

H mm	dim. mm	Obrada	JM	Šifra art.	Cijena sa PDV-om	
60	Ø40	alu	kom	780025	187€	14 ⁰⁹ kn
100	Ø40	alu	kom	780026	245€	18 ⁴⁶ kn
150	Ø40	alu	kom	780044	333€	25 ⁰⁹ kn
60	Ø40	mat crna	kom	780027	237€	17 ⁸⁶ kn
100	Ø40	mat crna	kom	780028	331€	24 ⁹⁴ kn
150	Ø40	mat crna	kom	780045	334€	25 ¹⁷ kn

Noga Riex GS36

Materijal: čelik

Noga ima podešavanje visine od 7 mm.

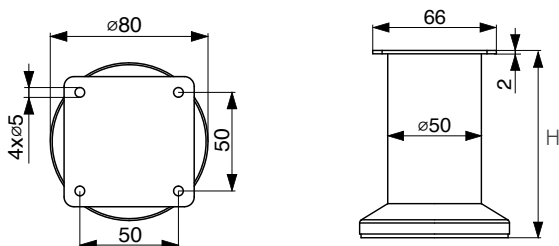

H mm	dim. mm	Obrada	JM	Šifra art.	Cijena sa PDV-om	
100	Ø50	četkani niki	kom	780007	350€	26 ³⁷ kn
100	Ø50	mat crna	kom	780008	373€	28 ¹⁰ kn
150	Ø50	mat crna	kom	780009	451€	33 ⁹⁸ kn
200	Ø50	mat crna	kom	780010	515€	38 ⁸⁰ kn

Noge za namještaj, kotačići i uredska oprema

Noga Riex GA33

Materijal: aluminij / plastika

Montaža na dno ormarića s 4 vijka. Noga ima podešavanje visine od 15 mm.

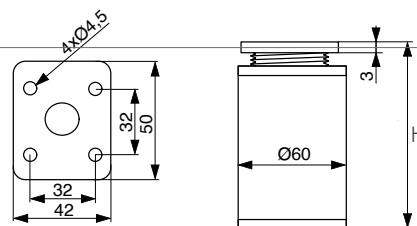

H mm	dim. mm	Obrada	JM	Šifra art.	Cijena sa PDV-om	
60	Ø60	alu	kom	780029	371€	27 ⁹⁵ kn
100	Ø60	alu	kom	780030	521€	39 ²⁵ kn
150	Ø60	alu	kom	780046	642€	48 ³⁷ kn
60	Ø60	mat crna	kom	780031	373€	28 ¹⁰ kn
100	Ø60	mat crna	kom	780032	502€	37 ⁸² kn
150	Ø60	mat crna	kom	780047	788€	59 ³⁷ kn

Noga Riex GS23

Materijal: čelik

Noga ima podešavanje visine od 7 mm.

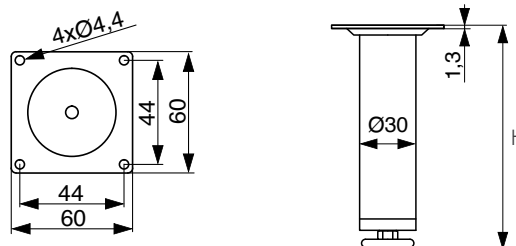

H mm	dim. mm	Obrada	JM	Šifra art.	Cijena sa PDV-om	
100	Ø30	mat krom	kom	780005	121€	9 ¹² kn
150	Ø30	krom	kom	780006	151€	11 ³⁸ kn
100	Ø30	mat crna	kom	780050	104€	7 ⁸⁴ kn
150	Ø30	mat crna	kom	780051	162€	12 ²¹ kn

Noge za namještaj

Noga

[DO ISTEKA ZALIHA](#)

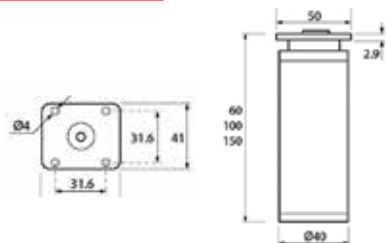

H	Obrada	JM	Šifra art.	Cijena sa PDV-om	
60	alu	kom	090005	233€	1752kn
100	alu	kom	090006	350€	2638kn
150	alu	kom	090007	449€	3383kn

Noga Riex GS29



Dimenzija	Obrada	JM	Šifra art.	Cijena sa PDV-om	
D50, H100	mat krom	kom	780095	179€	
D50, H150	mat krom	kom	780096	250€	

Noga

Materijal: čelik

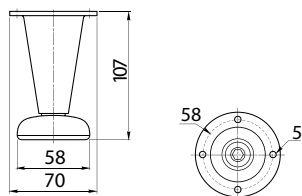

H	Obrada	JM	Šifra art.	Cijena sa PDV-om	
107	krom	kom	090155	551€	4150kn
107	nikal	kom	090156	551€	4150kn
107	aluminij	kom	090157	551€	4150kn

Noga



H	Ø	Obrada	JM	Šifra art.	Cijena sa PDV-om	
50	40		kom	070848	549€	4136kn
80	40		kom	070849	747€	5626kn
100	40		kom	070850	549€	4136kn

Noga

s regulacijom



H	Ø mm	Obrada	JM	Šifra art.	Cijena sa PDV-om	
100	30	krom sjaj	kom	550709	122€	
100	30	satini	kom	550211	203€	
150	30	krom sjaj	kom	550714	191€	
150	30	satini	kom	550212	259€	

Noga

Materijal: zamak + čelik

[DO ISTEKA ZALIHA](#)

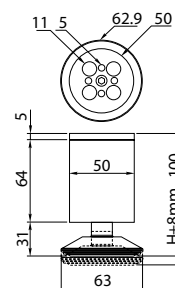

H	Obrada	JM	Šifra art.	Cijena sa PDV-om	
100	krom	kom	090162	582€	4387kn

Noga Riex GS25

Materijal: čelik

Noga ima podešavanje visine od 7 mm.

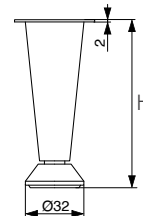
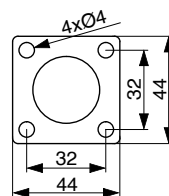

H mm	dim. mm	Obrada	JM	Šifra art.	Cijena sa PDV-om	
50	Ø32	mat crna	kom	780001	213€	1605kn
80	Ø32	mat crna	kom	780002	250€	1884kn

Noga

Metal



H	mm	Obrada	JM	Šifra art.	Cijena sa PDV-om	
100	40x40	siva	kom	071136	507€	3818kn
150	40x40	siva	kom	071137	660€	4971kn
200	40x40	siva	kom	071138	886€	6675kn

Noge za namještaj

Noga Riex GA77

Hranipex



Dimenzija	Obrada	JM	Šifra art.	Cijena sa PDV-om
D22, H150	četkano zlatna	kom	780093	904€
D22, H150	mat crna	kom	780094	904€

Noga Riex GA78

Hranipex



Dimenzija	Obrada	JM	Šifra art.	Cijena sa PDV-om
D22, H150	četkano zlatna	kom	780091	912€
D22, H150	mat crna	kom	780092	911€

Nogica za namještaj NS45

GAMET®

Materijal: čelik

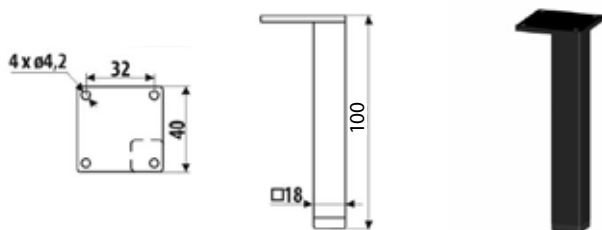

H	Obrada	JM	Šifra art.	Cijena sa PDV-om
100	crna	kom	670171	426€ 3208kn



Nogica za namještaj NS32

GAMET®

Materijal: čelik

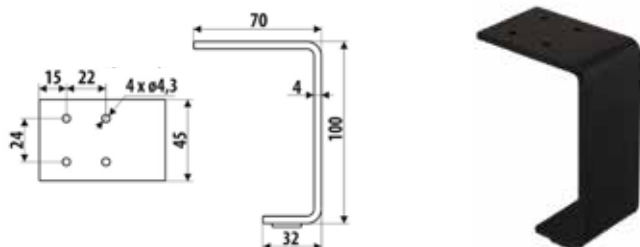

H	Obrada	JM	Šifra art.	Cijena sa PDV-om
100	crna	kom	670163	617€ 4650kn



Noga NA03

GAMET®

materijal: aluminij



H	Obrada	JM	Šifra art.	Cijena sa PDV-om
100	crna mat	kom	670159	978€ 7369kn
150	crna mat	kom	670160	1204€ 9072kn
270	crna mat	kom	670161	1304€ 9825kn

Smartfeet noga

materijal: plastika

emuca

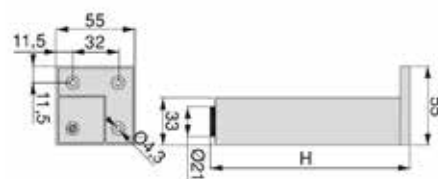

H	Obrada	JM	Šifra art.	Cijena sa PDV-om
100	crna mat	kom	820226	363€ 2734kn

Noge za namještaj

Nogica za namještaj NS37

Materijal: čelik

GAMET



dim mm	Obrada	JM	Šifra art.	Cijena sa PDV-om	
120x370	crna	kom	670164	13 ⁸² €	104 ¹⁴ kn

Noga Riex GS52

Materijal: čelik

Hranipex

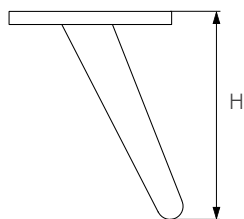
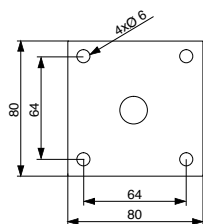

H mm	dim. mm	Obrada	JM	Šifra art.	Cijena sa PDV-om	
130	80x80	mat crna	kom	780020	1 ⁹⁸ €	14 ⁹² kn
170	80x80	mat crna	kom	780021	2 ²⁷ €	17 ¹⁰ kn
210	80x80	mat crna	kom	780011	4 ⁰¹ €	30 ²¹ kn

Noga Riex GS46

Materijal: čelik

Hranipex

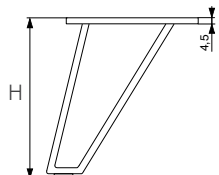
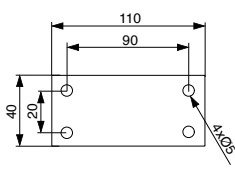

H mm	dim. mm	Obrada	JM	Šifra art.	Cijena sa PDV-om	
130	40x110	mat crna	kom	780018	3 ⁹⁶ €	29 ⁸⁴ kn
170	40x110	mat crna	kom	780019	4 ⁵⁰ €	33 ⁹¹ kn

Nogica za namještaj NS40

Materijal: čelik

GAMET

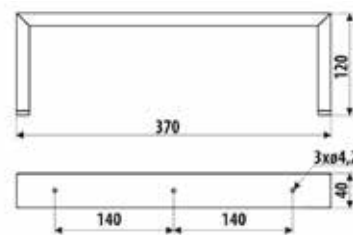

dim mm	Obrada	JM	Šifra art.	Cijena sa PDV-om	
120x370	crna	kom	670165	18 ¹⁶ €	136 ⁸² kn

Noga Riex GS53

Materijal: čelik

Hranipex

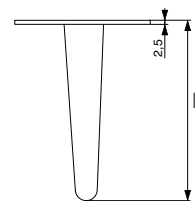
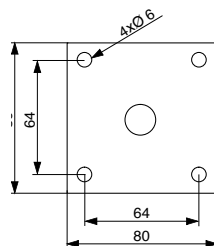

H mm	dim. mm	Obrada	JM	Šifra art.	Cijena sa PDV-om	
130	80x80	mat crna	kom	780022	2 ¹⁷ €	16 ³⁵ kn
170	80x80	mat crna	kom	780023	2 ⁶³ €	19 ⁸² kn

Noga

Materijal: čelik

GTV

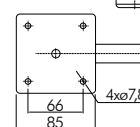
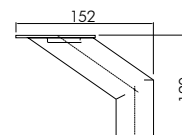

H	Obrada	JM	Šifra art.	Cijena sa PDV-om	
120	crna	kom	090395	5 ³¹ €	40 ⁰¹ kn

Noga Riex GS47

Materijal: čelik

Hranipex

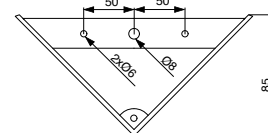
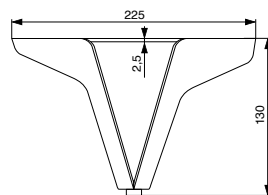

H mm	dim. mm	Obrada	JM	Šifra art.	Cijena sa PDV-om	
130	225x130	mat crna	kom	780024	3 ⁹³ €	29 ⁶¹ kn

Noge za namještaj

Noga

Čelik

DO ISTEKA ZALIHA

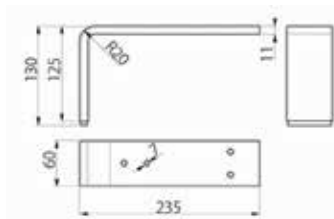

H	Obrada	JM	Šifra art.	Cijena sa PDV-om	
130	krom	kom	090165	993€	7478kn

Noga

Aluminium

DO ISTEKA ZALIHA

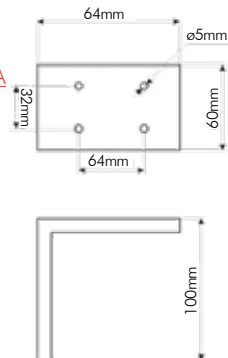

H	Obrada	JM	Šifra art.	Cijena sa PDV-om	
100	alu	kom	670031	1448€	10910kn



Noga Riex GW20

Materijal: drvo / metal

set: 4kom

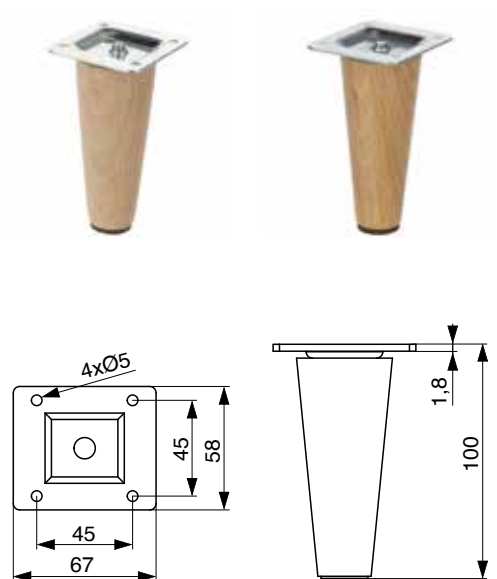

H mm	Obrada	JM	Šifra art.	Cijena sa PDV-om	
100	nelakirani prirodni hrast	set	780058	2633€	19838kn
100	lakirani prirodni hrast	set	780059	2707€	20396kn

Noga Riex GW20

Materijal: drvo / metal

set: 4kom

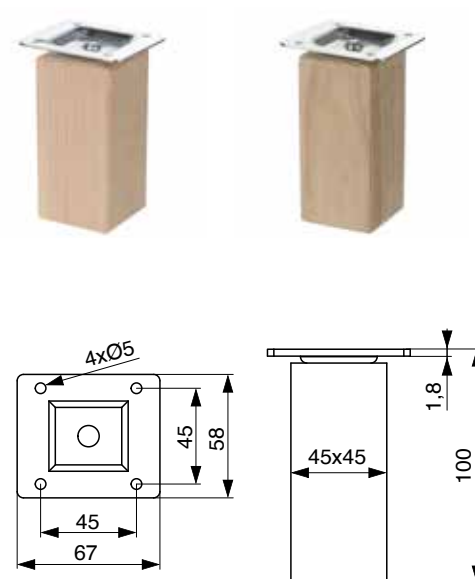

H mm	Obrada	JM	Šifra art.	Cijena sa PDV-om	
100	nelakirana prirodna bukva	set	780060	2048€	15431kn
100	nelakirani prirodni hrast	set	780061	2637€	19868kn

Noge za namještaj

Noga PVC

Plastika
rastavljiva (s opremom)



H	Obrada	KPL (kom)	JM	Šifra art.	Cijena sa PDV-om	
100	crna	4kom	kpl	0708900	337€	2540kn
150	crna	4kom	kpl	0708910	400€	3016kn

Podloška za nogu PVC

Plastika



H	Obrada	JM	Šifra art.	Cijena sa PDV-om	
	crna	kom	070932	017€	127kn

Noga PVC

Plastika
fiksna nogica



MM specijal ponuda na 2203020000:

40kom 25%
300kom 45%

H	Obrada	JM	Šifra art.	Cijena sa PDV-om
100	crna	kom	2203020000	038€
150	crna	kom	2203020001	049€

PVC nivelator noga

Plastika

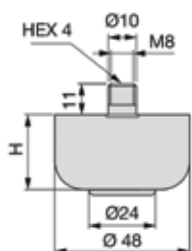

H	Nosivost	Obrada	JM	Šifra art.	Cijena sa PDV-om	
27	100kg	crna	kom	550683	090€	680kn

Noga PVC

Plastika, rastavljiva
Prodaja na pakete!



H	pak	Obrada	JM	Šifra art.	Cijena sa PDV-om	
100	400	crna	pak	070888	12441€	93735kn
150	200	crna	pak	070889	8650€	65177kn

Držac cokula



opis	JM	Šifra art.	Cijena sa PDV-om	
za pvc coklul	kom	180014	010€	074kn
za drveni cokul	kom	180015	010€	074kn

Noga PVC

Plastika
podešavajuća, nosivost 150kg,
idealno rješenje niveliranje velikih
ornara



H	Opis	JM	Šifra art.	Cijena sa PDV-om	
60	Nogica podeša. bez vijka	kom	0402640	120€	905kn
	Vijak za nogicu 45/60	kom	040283	071€	535kn

Podesiva nogica za sokl

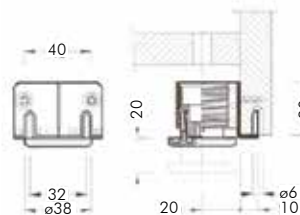

nosivost	JM	Šifra art.	Cijena sa PDV-om	
do 100kg + 20mm	kom	500490	105€	794kn

Kotačići

Kotačić

Nosivost 35kg

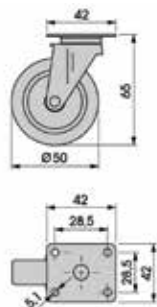

emuca

H	Ø	opis	JM	Šifra art.	Cijena sa PDV-om	
65	50	bez kočnice	kom	820133	4 ⁵⁹ €	34 ⁵⁵ kn
65	50	s kočnicom	kom	820135	8 ⁸⁵ €	66 ⁶⁸ kn

Kotačić

Nosivost 50kg

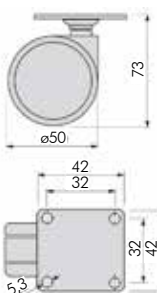

emuca

H	Ø	opis	JM	Šifra art.	Cijena sa PDV-om	
73	50	bez kočnice	kom	820024	5 ⁷⁸ €	43 ⁵³ kn
73	50	s kočnicom	kom	820025	6 ⁴⁷ €	48 ⁷⁵ kn

Kotačić

nosivost 25kg



GTV

H	Ø	opis	JM	Šifra art.	Cijena sa PDV-om	
55	40	sa kočnicom	kom	550557	0 ⁷⁹ €	5 ⁹⁵ kn
65	50	sa kočnicom	kom	070392	0 ⁹⁹ €	7 ⁴⁸ kn

Kotačić

Nosivost 64kg

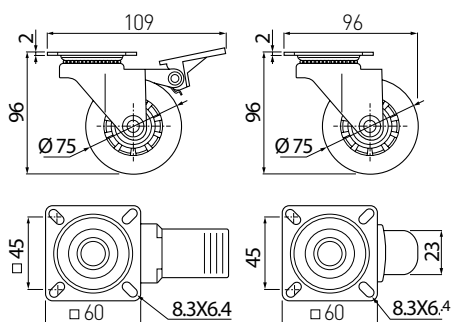

GTV

Kotačić

Nosivost 40kg

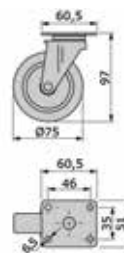

emuca

H	Ø	opis	JM	Šifra art.	Cijena sa PDV-om	
97	75	bez kočnice	kom	820134	6 ⁵⁵ €	49 ³³ kn
97	75	s kočnicom	kom	820136	9 ⁷⁵ €	73 ⁴⁵ kn

Kotačić

Nosivost 25kg

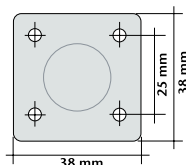

GTV

H	Ø	opis	JM	Šifra art.	Cijena sa PDV-om	
55	40	bez kočnice	kom	500171	0 ⁷⁰ €	5 ²⁷ kn
65	50	bez kočnice	kom	070393	0 ⁸³ €	6 ²⁴ kn

Kotačić s gumom

Širina x Visina: 53x65mm

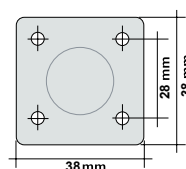

H	Ø	opis	JM	Šifra art.	Cijena sa PDV-om	
65	50	bez kočnice	kom	070843	2 ⁶⁸ €	20 ¹⁹ kn
65	50	sa kočnicom	kom	070844	2 ⁸⁶ €	21 ⁵⁵ kn

Kotadži prozirni

Nosivost 40kg

emuca

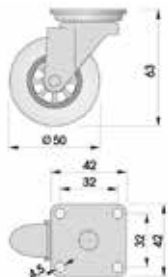

H	Ø	opis	JM	Šifra art.	Cijena sa PDV-om	
63	50	s kočnicom	kom	820137	8 ⁵⁶ €	64 ⁴⁹ kn
63	50	bez kočnice	kom	820131	7 ¹³ €	53 ⁷⁵ kn

Kotadži gumeni ravni

pocinčani čelik



H	Ø	opis	JM	Šifra art.	Cijena sa PDV-om	
51	50	gumeno kolo	kom	501623	7 ⁷⁴ €	58 ³⁵ kn

Kotadži PVC okretni

pocinčani čelik



H	Ø	opis	JM	Šifra art.	Cijena sa PDV-om	
36	30	plastično kolo	kom	501628	1 ⁵⁶ €	11 ⁷⁹ kn

Kotadži ukopni okretni

H	Ø	opis	JM	Šifra art.	Cijena sa PDV-om	
8	60	ukopni okretni	kom	501630	5 ⁶⁹ €	42 ⁸⁸ kn

Noge za namještaj, kotadži i uredska oprema

Fiksni kotadži

Metal, plastika, gumi



H	Ø	opis	JM	Šifra art.	Cijena sa PDV-om	
32	30	gumi	kom	070842	1 ⁵⁹ €	11 ⁹⁸ kn

Kotadži PVC ravni

pocinčani čelik



H	Ø	opis	JM	Šifra art.	Cijena sa PDV-om	
17	15	plastično kolo	kom	501624	1 ¹⁷ €	8 ⁸⁵ kn
29	25	plastično kolo	kom	501625	1 ¹² €	8 ⁴¹ kn
33	30	plastično kolo	kom	501626	1 ¹⁴ €	8 ⁵⁸ kn

Kotadži gumeni okretni

pocinčani čelik



H	Ø	opis	JM	Šifra art.	Cijena sa PDV-om	
36	30	gumeno kolo	kom	501627	2 ⁸⁹ €	21 ⁷⁵ kn

Kotadži gumeni ukopni okretni

H	razmak rupa	mm	JM	Šifra art.	Cijena sa PDV-om	
21	85x85	120x105	kom	501629	14 ⁴⁰ €	108 ⁵⁰ kn



Merida umetak za kabel



dim	obrada	JM	Šifra art.	Cijena sa PDV-om	
45 x 180 mm	alu	kom	090503	10 ³⁹ €	78 ²⁸ kn

Merida umetak za kabel



dim	obrada	JM	Šifra art.	Cijena sa PDV-om	
45 x 180 mm	crna	kom	090504	11 ⁴¹ €	85 ⁹⁷ kn

Rozeta za kabel



Ø	obrada	JM	Šifra art.	Cijena sa PDV-om	
60	nikal satinirana	kom	090079	3 ⁶² €	27 ²⁷ kn
60	aluminij	kom	090080	3 ⁸⁸ €	29 ²³ kn
80	nikal satinirana	kom	090081	4 ⁴⁵ €	33 ⁵³ kn
80	aluminij	kom	090082	5 ³⁷ €	40 ⁴⁶ kn

Rozeta za kabel

materijal: PVC



crna bijela siva svijetlo
smeđa



Ø	Ø out	H	obrada	JM	Šifra art.	Cijena sa PDV-om	
60	70	20	crna	kom	740031	0 ⁷⁰ €	5 ²⁶ kn
60	70	20	bijela	kom	740032	0 ⁷⁰ €	5 ²⁶ kn
60	70	20	siva	kom	740033	0 ⁷⁰ €	5 ²⁶ kn
60	70	20	svijetlo smeđa	kom	740034	0 ⁷⁰ €	5 ²⁶ kn

- Vodilicu za tastaturu potražite u sekciji Sustav vodilica i box sustavi



820062